



Motion detectors

- theMura S180-100 UP WH
2060650
- theMura S180-100 UP N WH
2060653
- theMura S180-100 2W UP WH
2060670
- theMura S180-100 UP F WH
2060654
- theMura S180-100 2W UP F WH
2060674

Presence detectors

- theMura S180-101 UP WH
2060655
- theMura S180-101 2.20 UP WH
2060658

Motion/presence detectors

- theMura S180 Slave UP WH
2060660

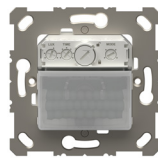

Motion detectors

- theMura S180-100 B UP
2060750
- theMura S180-100 2W B UP
2060770

Presence detectors

- theMura S180-101 B UP
2060755

Motion/presence detectors

- theMura S180 Slave B UP
2060760

1. General information

- Passive infrared motion/presence detector for wall mounting in device housing
- Rectangular detection area (max. 14 m x 17 m) (16 x 10 m at 2060658)
- Mixed light measurement suitable for fluorescent lamps (FL/PL/ESL), halogen/incandescent lamps and LEDs
- Integrated buttons
- **Different models:**
 - theMura S180-100:** motion detector for normal requirements
 - theMura S180-101:** presence detector with additional functions, e.g. orientation light, acoustic function, additional channel H (isolated) etc.
 - theMura S180 Slave:** for master/slave switching
 - theMura S180-100 2W:** 2-wire motion detector combined with a staircase light timer switch ELPA
- **Optional accessories:**
 - theMura S180-101:** theSenda S user remote control (9070911) (theSenda S for short); theSenda P service remote control (9070910) (theSenda P for short); theSenda B app remote control (9070985) and the corresponding "theSenda Plug" app (iOS/Android) (theSenda B/app for short); bezel frames adapted for different switch ranges (can be ordered optionally)
 - theMura S180-100:** bezel frames adapted for different switch ranges (can be ordered optionally), see www.theben.de/theMura

2. Safety



Assembly and installation should only be carried out by a qualified electrician, somebody who has completed appropriate professional training and has the knowledge and experience necessary to be able to recognise and avoid the potential dangers posed by electricity.



Before installation/disassembly, disconnect the power supply and ensure that the parts are no longer live.



Prior to commissioning and using the product, read the entire manual and follow the instructions.

3. Proper use

- The detector controls the lighting and HVAC (depending on the model).
- It is designed for wall mounting in an interior switch range, e.g. in a corridor, staircase, cellar, toilet, etc.
- For use in normal ambient conditions.

4. Connection



Use the same external conductor for all detectors and buttons.



Illuminated buttons can only be used with a neutral conductor connection.



Secure device with an upstream type B or type C circuit breaker (EN 60898-1) with a maximum of 10 A (L/L↓).



Secure device with an upstream type B or type C circuit breaker (EN 60898-1) with a maximum of 2 A (H1/H2).

Individual switching (3-wire detector)

As master, the detector detects presence and brightness and controls lighting.

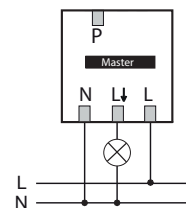

theMura S180-100 UP

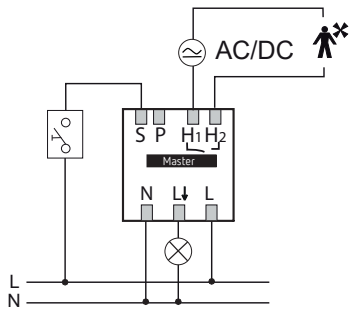

theMura S180-101 UP
theMura S180-101 2.20 UP WH

Master/slave parallel switching (3-wire detector)

If the detection area covered by a single detector is insufficient (in large rooms), then several detectors can be operated in parallel by connecting the P terminals. The master measures brightness and controls the lighting. The other detectors (theMura slaves) merely provide presence information.

- ① A maximum of 6 detectors can be connected over a length of 50 m.

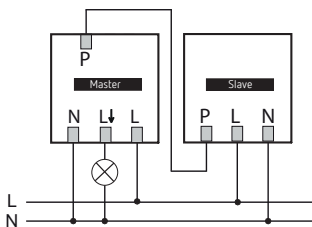

theMura S180-100 UP and
theMura S180 Slave UP

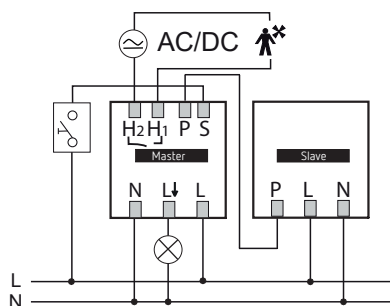

theMura S180-101 UP and
theMura S180 Slave UP

Switching (2-wire detector) with staircase light timer switch

- ① To switch the load, the 2-wire detector always requires a staircase light timer switch, e.g. a Theben-ELPA 3, ELPA 6, ELPA 6 plus, ELPA 8 or ELPA 041.
- ① Please bear in mind the max. number of detectors:
max. 12 detectors with ELPA 1, 3, 6, 6 plus, 8
max. 6 detectors with ELPA 041, 047
- ① The time delay is set at the staircase light timer switch.

- ⚠ Do not connect the lighting directly to the detector!
- ⚠ The 4-conductor switching must be used for the staircase light timer switch.

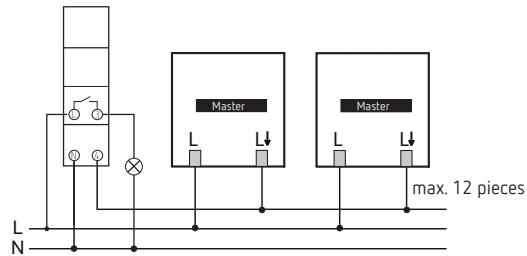

e.g. ELPA 2 x theMura S180-100 2W UP
only Theben devices

5. Installation

- ① For installation in device housing, concealed housing size 1.
- ① Optionally available with buttons and bezel frame; if necessary bezel frames from other switch ranges can be used.
- ① Observe the recommended installation height!
- ① Ensure that there are no obstructions as infrared rays cannot pass through solid objects.
- ① The detector is not suitable for intruder alarm systems!

Installation of theMura S180-100 UP etc.

- ① Observe the installation height of 0.8 m - 1.2 m!

Detection area

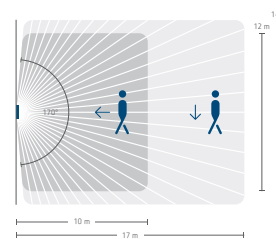
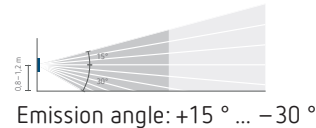

Installation of the Mura S180-101 2.20 UP WH

① Observe the installation height of 2,2 m!

Detection area

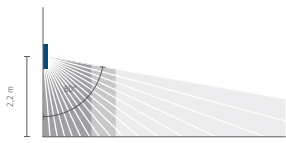

Emission angle: 80 °

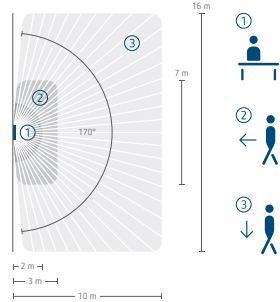

Detection angle: 170 °

Limiting the detection area

- Use the enclosed stickers to adjust the motion detector to the desired detection area.
- Remove the required section of the sticker by using scissors
- Then stick it to the lens.

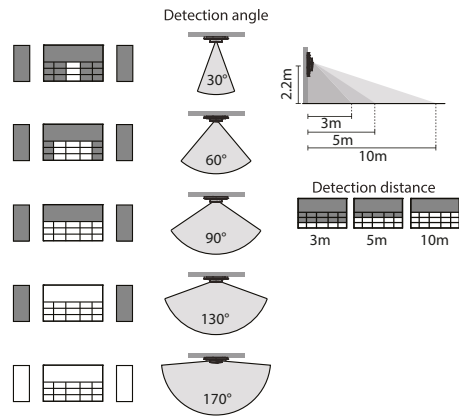
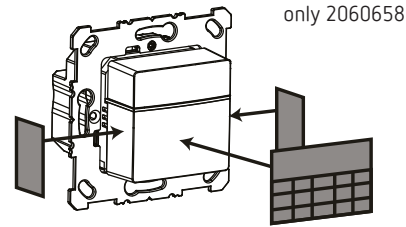
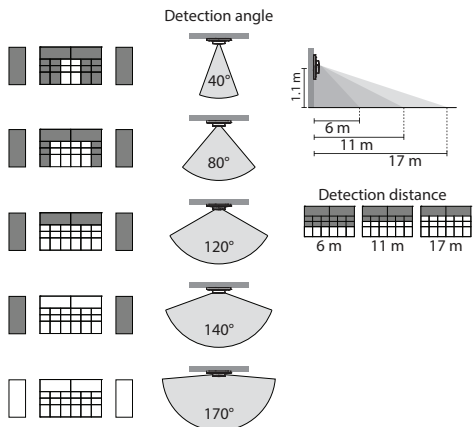
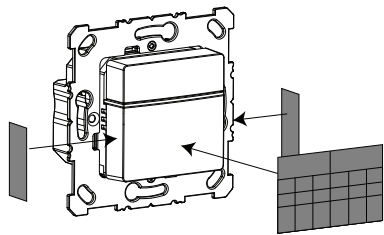

Flush-mounted installation

with a standard flush-mounting box, size 1 (see illustration)

- Disconnect power source.
- Connect detector according to the wiring diagram (see section 4).
- Screw down the detector in the flush-mounted box ①.
- Position the button and bezel frame on the detector ② ③.

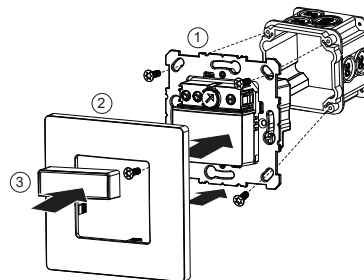
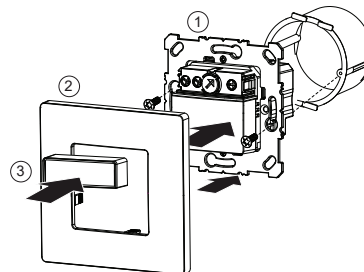

Installation for 2060654 and 2060674 only

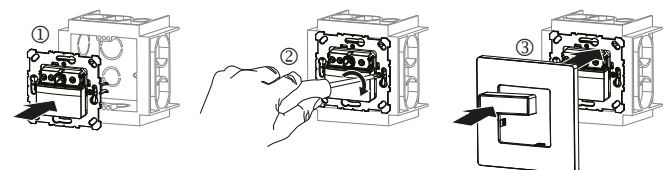

- Turn the screw to the left and right to tighten the clamps.
- Use a PH1 screwdriver.

6. Description and settings

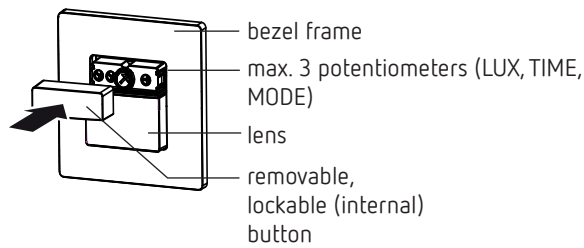

Setting options via potentiometer

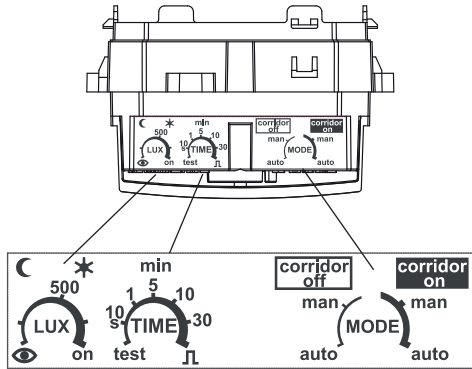

Setting the brightness (LUX)

You can set different brightness values with the brightness potentiometer (factory setting 500 lx).



- Set potentiometer to desired switch-on brightness (5 – 1000 lux/on).
On the **on** setting the detector always responds to movement, regardless of the brightness.
- Turn the potentiometer to **Teach-in** ; after 20 s (red LED flashes) the detector saves the current surrounding brightness as the new switch-on brightness.

⚠ Teach-in at 2-wire motion detector (theMura S180-100 2W)

- Set the time delay at the staircase light timer switch to minimum.
- Set the potentiometer to **teach-in** .
→ The detector saves the current surrounding brightness after 75 s (red LED flickers) as the new switch-on brightness.
- Set the desired time delay at the staircase lighting timer switch.

Setting the time delay (TIME)

If the detector detects no further movement, it switches off after the set time delay. If you want to change the preset time (factory setting 10 min)

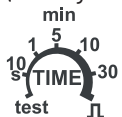

- Set the potentiometer to the desired time (10 s, 1 min, 5 min, 10 min, 30 min).

If you wish to use the pulse function (e.g. for a staircase light timer switch)

- Set the potentiometer to . As long as motion is detected, the contact closes every 10 s for 0.5 s.
- ⓘ At the 2-wire motion detector (theMura S180-100 2W), no time delay can be set. The time delay set on the staircase lighting timer switch applies. The time delay of the staircase light timer switch is restarted at regular intervals in case of motion or when the light falls below the brightness setpoint.

Test detection area (walking test)

The walking test is used to test the detection area and to restrict it if necessary.

- Set the time potentiometer (TIME) to **test**.
→ The detector always responds to movements (regardless of brightness and configuration type).
→ After the detector has detected a movement, all contacts switch on for 2 s.
- ⓘ At the 2-wire motion detector (theMura S180-100 2W), the contact does not switch during the detected motion.
→ If motion is detected the red LED on the master lights up.

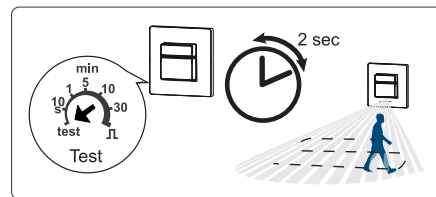

Performing the walking test using the button (only for slave devices)

- Press the button for 10 s.
→ If motion is detected the red LED on the slave lights up.
→ Test mode is activated for 10 min.
- Briefly press the button.
→ The test mode is ended and the detector returns to normal operation.

Recommended guide values

Transit zones (not work areas)	approx. 5 min
School rooms, basements	approx. 10 min
Work areas (office, etc.), toilets	approx. 10 min

Setting the MODE (fully or semi-automatic) with staircase light function

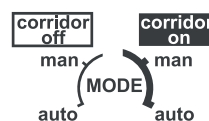

Staircase light function – corridor off/corridor on

With the **corridor off** staircase light function the light can be switched on and off manually using the button at any time. With **corridor on** it can be switched on manually but not switched off. The light will not be switched off again until after the set time delay.

Configuration type – auto/man

auto = fully automatic

The lighting is switched on and off automatically (based on presence, absence and brightness).

man = semi-automatic

The lighting is always switched on manually. It is switched off by the detector.

7. Manual operation using the button (internal or external)

The button can be used to manually switch the lighting at any time. The response varies depending on the detector type.

Switching on manually

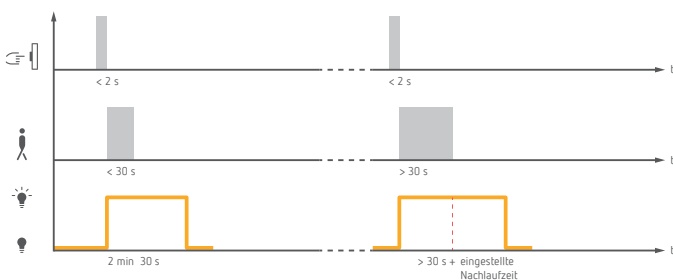

theMura S180-100

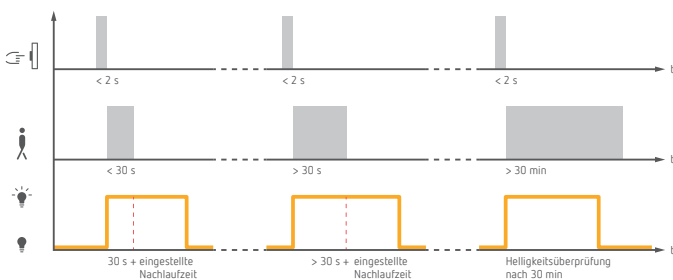

theMura S180-101

When the button is pressed briefly, the light switches on for a certain time (depending on the duration of motion and the set time delay).

- ① With theMura S180-101, the surrounding brightness is checked after 30 min. If there is sufficient brightness, the light is switched off despite the presence of persons.

Switching off manually

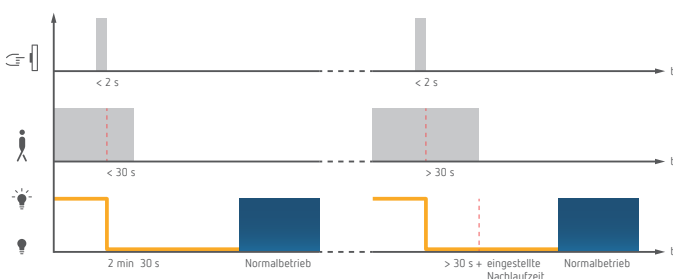

theMura S180-100

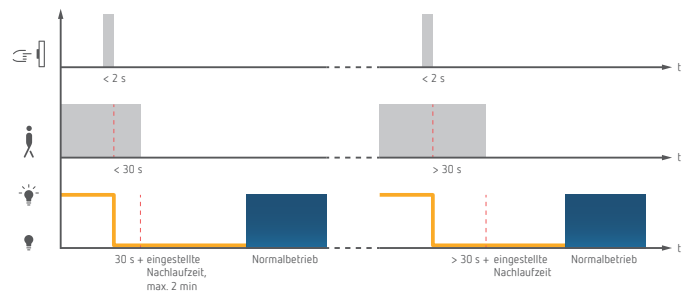

theMura S180-101

If the light is switched on, it can be switched off for a certain time by briefly pressing the button (depending on the duration of the motion  and the set time delay). Afterwards, the detector returns to normal operation.

- ① In the case of the 2-wire motion detector, when the button is pressed only a short pulse is sent to the staircase light timer switch.

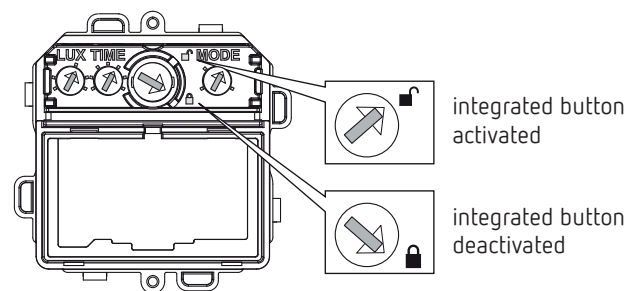

Extended function

With a long press on the internal or external button, the lighting channel can be overridden for a certain period of time.

- ① The extended function is not active if the time delay of the lighting channel is set to **pulse** or the staircase light function is activated.

Activating the function

- Press the button for 3 s and release it.
 - The LED flashes 2 x; the lighting is switched on for the set time (for theMura S180-100 UP fixed 4 h); after activation, the LED flashes 2 x briefly every 10 s.
- Press the button for > 6 s and release it.
 - The LED flashes 3 x; the lighting is switched off for the set time (for theMura S180-100 UP fixed 4 h); after activation, the LED flashes 2 x briefly every 10 s.

Leaving the function

- Briefly press the button 1 x.

8. Parameters and control commands via remote control

- ① Only with presence detectors (2060655+2060658+2060755)

The following parameters can be checked or changed via the remote control for support during start-up as well as servicing:

9. Parameters and control commands via app

1. Parameters

Brightness setpoint value A

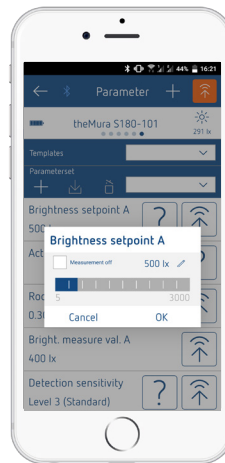

theSenda B/app



theSenda P

Brightness actual value A

Check of the current measured actual brightness value.

► Follow the instructions in the app.

Room correction factor A

The room correction factor is a measurement for the difference of the brightness measurement at the wall and the floor. The brightness measurement value at the wall is influenced by the installation location, incidence of light, position of the sun, weather conditions, the reflection properties of the room, and the furniture.

With the room correction factor, the brightness measurement value of lighting channel A is adjusted to the conditions in the room. The standard value is 0.3 and is suitable for most applications. Changes are only sensible in strongly deviating situations.

Brightness measurement value A

When the actual brightness measurement is sent to the detector, the room correction factor is recalculated.

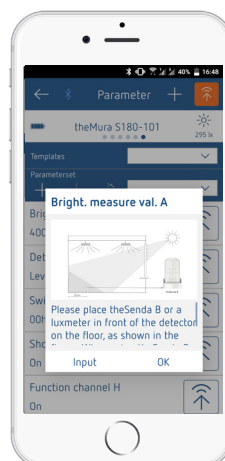

Parameter	theSenda B/ app check	Can be changed by theSenda B/ app	Can be changed by theSenda P
Brightness setpoint value A	X	X	X
Brightness actual value A	X		
Room correction factor A	X	X	
Brightness measurement value A		X	
Detection sensitivity	X	X	X
Time delay A		X	X
Short presence A		X	
Channel function H		X	
Time delay H		X	X
Switch-on delay H		X	
Configuration type		X	X
Staircase light function		X	
Orientation light time delay		X	
Orientation light brightness		X	
Extended function duration		X	
Acoustic sensor sensitivity		X	
LED display motion		X	

- ④ The parameters are sent to the detector by infrared.
Changed parameters are applied and used.

To check the parameters

► press the button and follow the instructions in the app.

The following control commands can be triggered with the remote control:

Control command	Can be triggered by theSenda B/ app	Can be triggered by theSenda P	Can be triggered by theSenda S
Teach-in channel A	X	X	
Switching light	X	X	X
Test detection area	X	X	
Restart	X	X	
Factory settings	X		

Connecting a mobile end device to theSenda B/ app remote control

- Open the theSenda Plug app.
- Press the Bluetooth symbol in the app on the top left-hand side.
- Briefly press the Bluetooth button on theSenda B
→ LED flashes red, devices are searched for.
- Confirm with OK.
→ LED lights up red.

- After selecting the parameter **brightness measurement value A** either press **input** and enter brightness measurement value A manually
- or follow the instructions in the app and confirm with OK.
→ The current brightness measurement value is displayed.
- Confirm with OK.
- Send the current brightness measurement value to the detector.

Detection sensitivity

The detector has 3 sensitivity levels:

Level	Sensitivity
1	Very insensitive
2	Insensitive
3	Standard (default)

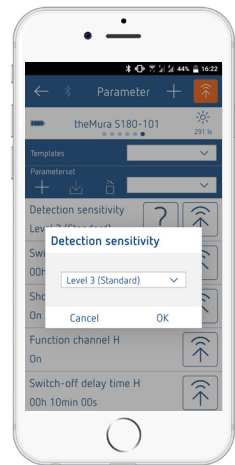

theSenda B/app



theSenda P

Time delay A

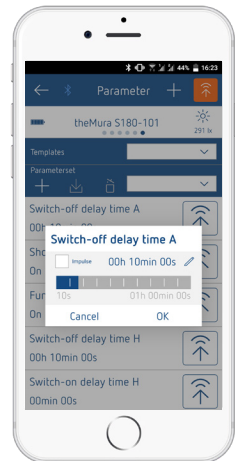

theSenda B/app



theSenda P

Short presence A

If a room is only occupied briefly, the channel A time delay is ended early (2 min), provided that the set time delay is > 2 min.

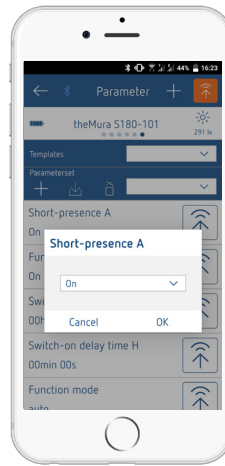

Channel function H

Channel H presence (isolated contact), e.g. to control a fan in the bathroom, switches in case of a presence, regardless of whether configuration type is set to **man** or **auto**. This function can also be deactivated.

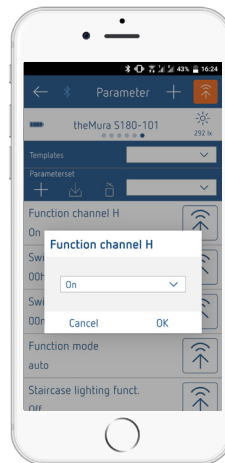

Time delay H

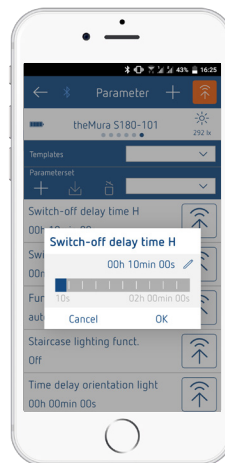

theSenda B/app

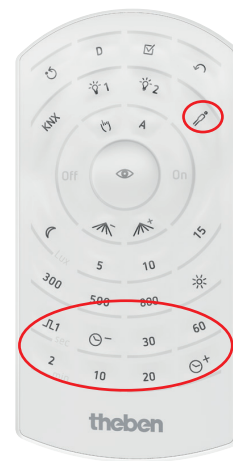

theSenda P

Switch-on delay H

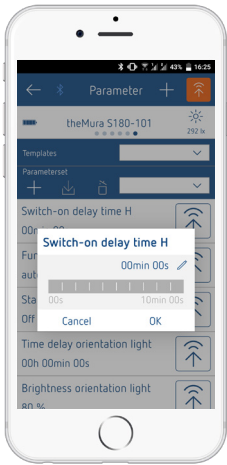

Configuration type

auto = fully automatic

The lighting is switched on and off automatically (based on presence, absence and brightness).

man = semi-automatic

The lighting is always switched on manually. It is switched off by the detector.



theSenda B/app



theSenda P

Staircase light function

With the **off** staircase light function the light can be switched on and off manually using the button at any time. With **on** it can be switched on manually but not switched off. The light will not be switched off again until after the set time delay.

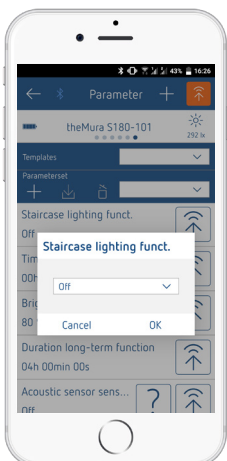

Orientation light time delay

The integrated orientation light conveys a sense of security and good orientation in dark rooms and corridors.

Time delay

When the channel A time delay has expired, the orientation light comes on for the set time delay.

On

The orientation light always comes on when the room is unoccupied if the set brightness target value A is not reached.

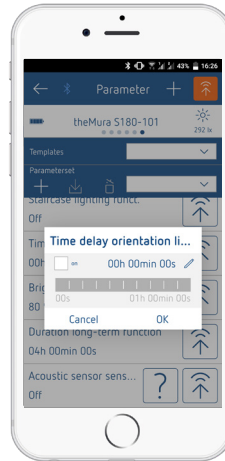

Orientation light brightness

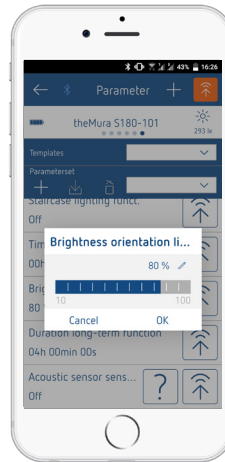

Extended function duration

With a long press on the internal or external button, channel A can be overridden for a certain period of time (see chap. 7. Manual operation using the button – internal or external).

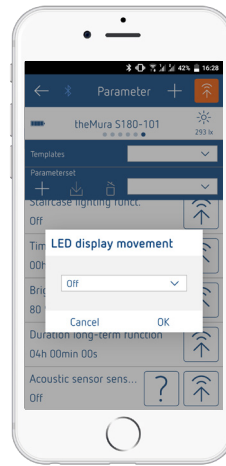
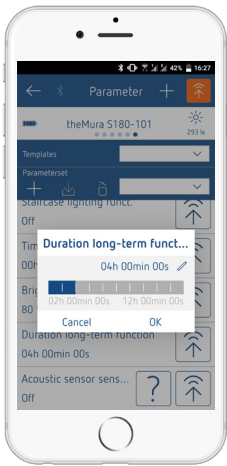

Acoustic sensor sensitivity

An integrated microphone complements motion detection and enables use even in rooms with alcoves. The function is activated as soon as the light (channel A) is switched on. Each time an acoustic signal is detected the channel A time delay is restarted. If the light goes out, the microphone is only activated briefly.

① If the set brightness target value A is exceeded, the microphone is switched off.

Level	Sensitivity
Off	Deactivated (default)
1	Insensitive
2	Standard
3	Sensitive

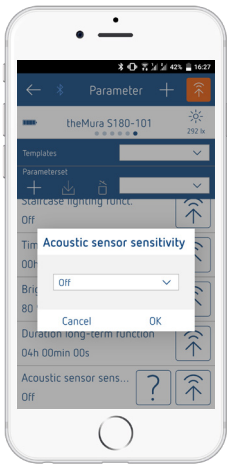

LED display motion

Motion detection is indicated by the LED.

2. Control commands

Teach-in channel A

The detector saves the current surrounding brightness as the new switch-on brightness.

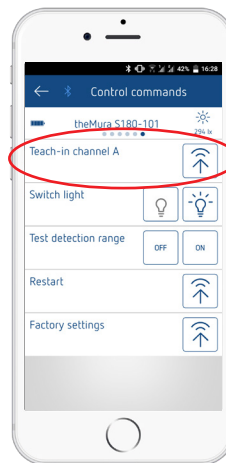

theSenda B / app

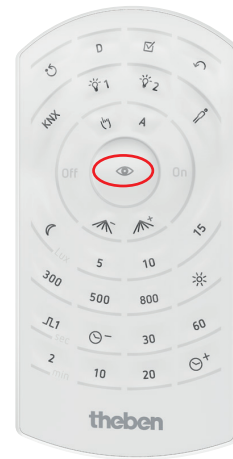

theSenda P

Switching light (on/off)

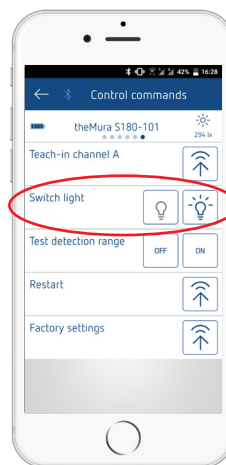

theSenda B / app



theSenda B



theSenda P



theSenda S

Factory settings



Test detection area (walking test)

The walking test is used to test the detection area and to restrict it if necessary.

► Select ON in the app.

- The detector always responds to movement (regardless of brightness and configuration type).
- After the detector has detected a movement, all contacts switch on for 2 s.
- If motion is detected the red LED on the master lights up.



theSenda B/app



theSenda P

Parameter	theMura S180-101 UP
Brightness setpoint value A	500 lux
Room correction factor A	0.3
Detection sensitivity	3
Time delay A	10 min
Short presence A	On
Channel function H	On
Time delay H	10 min
Switch-on delay H	0 s
Configuration type	Auto
Staircase light function	Off
Orientation light time delay	0 s
Orientation light brightness	80%
Extended function duration	4 h
Acoustic sensor sensitivity	Off
LED display motion	Off

Switch-on behaviour

Start-up phase (45 s) after restoration of power

- The red LED flashes at one second intervals, all switch contacts are closed.
- The detector does not respond to push button commands and remote control commands.
- When no one is present, all contacts open after 45 s.

Operation

- The detector is ready for operation (LED off).

LED display

LED	Description
Flashes at 1 second intervals	The presence detector is in the start-up phase.
Flickers for 2 s	The command sent from the remote control via infrared was accepted by the presence detector.
Lights up briefly	The command sent from the remote control via infrared was rejected by the presence detector. The command is not valid. Check the selected detector type or parameters in the app.
Flashes rapidly	Error flashing; the presence detector has found an error.
Flickers for 20 s	Teach-in via potentiometer is activated.
Lights up or flickers irregularly	The presence detector is in presence test mode or "LED display movement" is activated. The LED detects movements.

Restart



theSenda B/app



theSenda P

10. Troubleshooting

Fault	Cause
Light does not switch on or off if presence is detected and in darkness	Lux value is set too low; detector set to semi-automatic; light was switched off manually via button or remote control; person not within detection area; obstruction(s) interrupting detection; time delay set too short
Light stays on with detection of presence despite sufficient brightness	Lux value is set too high; light was briefly switched on manually via button or with the remote control (wait 30 min.); detector is in test mode
Light does not switch off, or light switches on spontaneously when no one is present	Thermal sources of interference in the detection area: fan heaters, incandescent lamps/halogen spotlights, moving objects (e.g. curtains hanging in open windows); load (EBs, relays) not cleared
Button does not work	Device still in the start-up phase; illuminated button was used without neutral conductor; push button not fed to the master
Light cannot be switched off with the button	Button is not connected to the detector. Check the button wiring.
Device does not respond	Short circuit or several phases in parallel switching! Disconnect detector from the power supply for 5 min (thermal fuse)
Error flashing (4 x per second)	Error in self-test; device not functional!

11. Technical data

Operating voltage:	230 V AC, + 10% / - 15%
Frequency:	50/60 Hz
Standby output:	0.4 W +/- 15% (without orientation light)
Switching load:	L/L ↓: 10 A with $\cos \varphi = 1$; H1/H2: 2 A with $\cos \varphi = 1$ (only 2060655 + 2060658 + 2060755), 2060660 + 2060760 do not switch any load
Minimum load:	10 mA
Contact type A:	μ contact
Switching capacity A:	
Incandescent/halogen lamp load:	2060650 + 2060654 + 2060653 + 2060750, 2060655 + 2060658 + 2060755: 2300 W
Compact/fluorescent lamps:	2060650 + 2060654 + 2060653 + 2060750, 2060655 + 2060658 + 2060755: 1150 VA
LED lamps:	2060650 + 2060654 + 2060653 + 2060750, 2060655 + 2060658 + 2060755: < 2 W: type. 40 W > 2 W: type. 450 W 2060660 + 2060760: - 2060670 + 2060674 + 2060770: *
Switching capacity H:	50 W/50 VA (max. 2 A) (2060655 + 2060658 + 2060755)
Contact type H:	μ contact
Protection rating:	IP 20 in accordance with EN 60529
Protection class:	II in accordance with EN 60598-1
Operating temperature:	-15 °C ... +45 °C
Brightness setting range:	- 2060650 + 2060654 + 2060653 + 2060750: 5 - 1000 lx - 2060655 + 2060658 + 2060755: 5 - 3000 lx - 2060660 + 2060760: - - 2060670 + 2060674 + 206065 + 2060770: 5 - 1000 lx
Presence time delay:	10 s - 120 min (2060655 + 2060658 + 2060755)

Lighting time delay:	- 2060650 + 2060654 + 2060653 + 2060750: pulse, 10 s - 30 min - 2060655 + 2060658 + 2060755: pulse, 10 s - 60 min - 2060660 + 2060760: - - 2060670 + 2060674 + 2060770: pulse In the case of switching with 2060670 + 2060674 and 2060770 the turn-on time corresponds to the time set on the staircase light timer switch.
Presence switch-on delay:	0 s - 10 min (2060655 + 2060658 + 2060755)
Installation height	0.8 - 1.2 m (2.20 m at 2060658)
Detection angle:	170°
Detection area:	
- across	14 x 17 m (16 x 10 m at 2060658)
- frontal	12 x 10 m (7 x 3,5 m at 2060658)
Software class:	A
Energy efficiency class:	A+

* only for staircase light timer switch control

Cleaning and service

- Only use a dry, soft cloth to clean the device surface.
- Do not use any cleaning agents or solvents.

Disposal



Dispose of the appliance separately from domestic waste at an official collection point.

12. Dimensional drawings

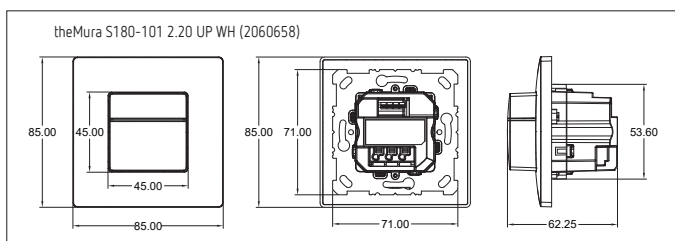
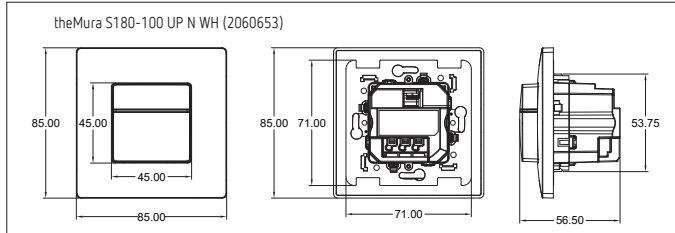
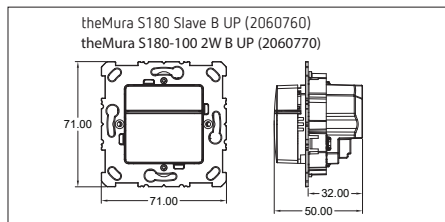
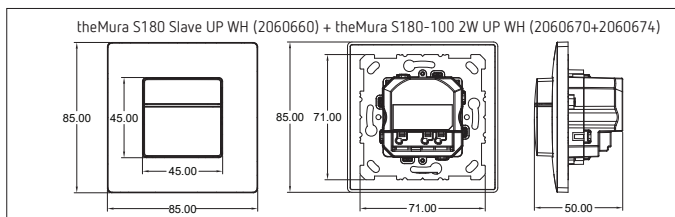
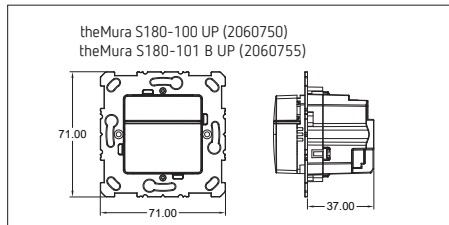
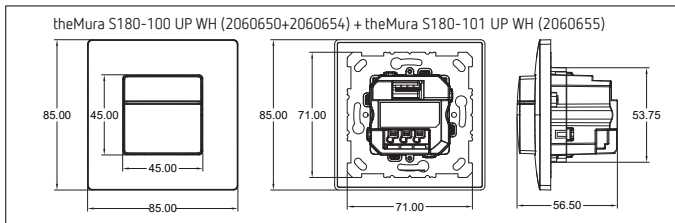

13. Contact

Theben AG
Hohenbergstr. 32
72401 Haigerloch
GERMANY
Phone +49 7474 692-0
Fax +49 7474 692-150

Technical Support
Phone +49 7474 692-369
techsupport@theben.de
www.theben.de