

EN Presence detector

LUXA 103 S360-100-12 DE-UP WH	1030052
LUXA 103 S360-100-12 DE-UP AN	1030152
LUXA 103 S360-101-12 DE-UP WH	1030053
LUXA 103 S360-101-12 DE-UP AN	1030153
LUXA 103 S360-100-12 AP WH	1030062
LUXA 103 S360-100-12 AP AN	1030162
LUXA 103 S360-101-12 AP WH	1030063
LUXA 103 S360-101-12 AP AN	1030163
LUXA 103 S360-100-28 DE-UP WH	1030072
LUXA 103 S360-100-28 DE-UP AN	1030172
LUXA 103 S360-100-28 AP WH	1030082
LUXA 103 S360-100-28 AP AN	1030182



1030052/1030152



1030062/1030162



1030072/1030172



1030053/1030153



1030063/1030163



1030082/1030182

1. General information

- Presence detector for ceiling installation (false ceiling), flush mounting in standard box and surface mounting
- Suited for mixed light measurement
- Functions adjustable with remote control theSenda P and theSenda B/app; functions for the user can be called up via theSenda S
- Detection area: presence detector circular Ø 12 m; corridor detector rectangular 28 x 5 m
- **Various versions:**
LUXA 103 S360-100-12 DE-UP WH/AN: for ceiling installation and flush mounting, 1 switching channel for light
LUXA 103 S360-101-12 DE-UP WH/AN: for ceiling installation and flush mounting, 1 switching channel for light, 1 potential-free contact for HVAC
LUXA 103 S360-100-12 AP WH/AN: for surface mounting, 1 switching channel for light
LUXA 103 S360-101-12 AP WH/AN: for surface mounting, 1 switching channel for light, 1 potential-free contact for HVAC
LUXA 103 S360-100-28 DE-UP WH/AN: for ceiling installation and flush mounting, 1 switching channel for light
LUXA 103 S360-100-28 AP WH/AN: for surface mounting, 1 switching channel for light

• **Optional accessories:**

Adapter set Switzerland 9070842; surface-mounted frame 9070843, 9070844
theSenda S user remote control (9070911) (theSenda S for short), theSenda P service remote control (9070910) (theSenda P for short), theSenda B app remote control (9070985) and the corresponding "theSenda Plug" app (iOS/Android) (theSenda B/app for short)

2. Safety



Assembly and installation should only be carried out by a qualified electrician, somebody who has completed appropriate professional training and has the knowledge and experience necessary to be able to recognise and avoid the potential dangers posed by electricity.



Before installation/disassembly, disconnect the power supply and ensure that the parts are no longer live.



Prior to commissioning and using the product, read and observe all the operating instructions.

The presence detectors conform to EN 60669-2-1 if correctly installed.

3. Proper Use

- Presence detector for automatic lighting control and HVAC (depending on version)
- Suited for ceiling installation (false ceilings), flush mounting in standard box (1030052/1030152, 1030053/1030053, 1030072/1030172) or surface mounting (1030062/1030162, 1030063/1030163, 1030082/1030182) indoors and outdoors:
Detector with circular detection area for individual and open-plan offices, toilets, basements, etc.;
Detector with rectangular detection area (1030072/1030172 + 1030082/1030182) so called → **corridor detector** for aisles and corridors

4. Installation

Installation instructions

As the detector reacts to variations in temperature, avoid the following situations:

- Do not point the presence detector at objects with highly reflective surfaces such as mirrors, etc.
- Do not install the presence detector near heat sources such as heating vents, air conditioners, lamps, etc.
- Do not point the presence detector at objects that move in the wind such as curtains, large plants, etc.

► Pay attention to the direction of motion during the test run.

- ① Prior to installation, you may need to make settings at the potentiometers.
 - ① Observe the recommended installation height of 2.5 – 6.0 m!
 - ① Ensure that there are no obstructions, as infrared rays cannot pass through solid objects.
 - ① When mounting the corridor sensor (1030072/1030172, 1030082/1030182), pay attention to correct alignment.
- Disconnect power source.

Installation in false ceiling (ceiling installation)

- ① This type of installation applies to detectors 1030052/1030152, 1030053/1030153, 1030072/1030172.
- Create a ceiling opening of approx. \varnothing 60 mm.
- Strip the cable to 8 – 10 mm according to the device labelling.
- Connect the device as shown in the figure, attach the cord grip using the cable ties supplied and fit the transparent touch protection cap.
- Press the springs upwards and push the device into the ceiling opening.

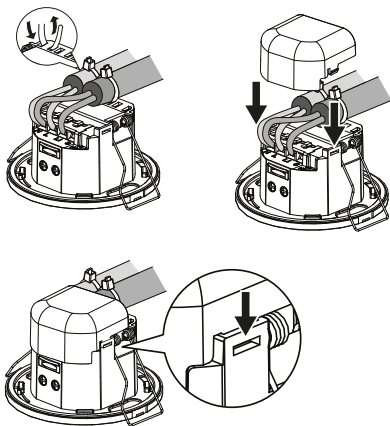

Ceiling opening \varnothing 60 mm

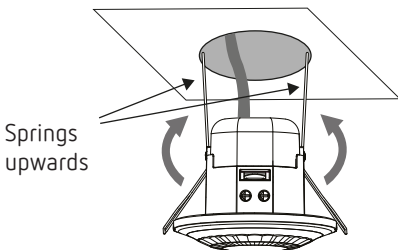

Springs in correct position

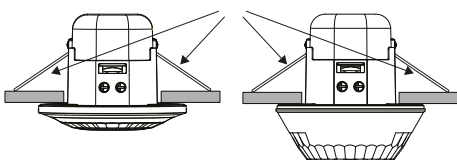

Flush mounting

- ① This type of installation applies to detectors 1030052/1030152, 1030053/1030153, 1030072/1030172.
- ① To fit the devices into a box, the springs and the touch protection cap must be removed.
- Strip the cable to 8 – 10 mm according to the device labelling.
- Connect and assemble the device as shown in the figure.

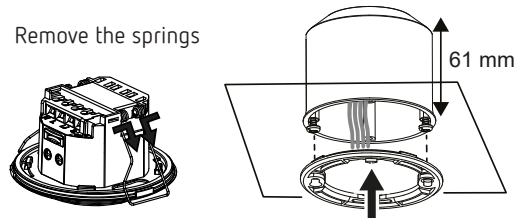

- ① A box with a minimum depth of 61 mm provides the optimum installation conditions.

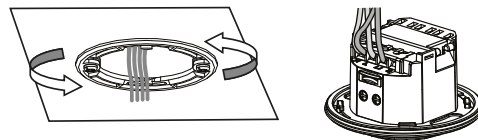

- Screw the mounting frame onto opposite sides of the flush-mounted box.
- Connect the device.

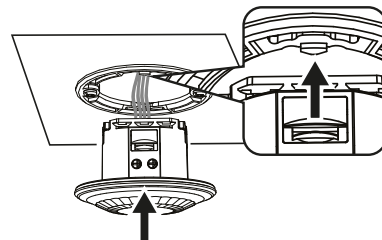

- Slide the device over the first resistance in the box (see figure) and fix it to the mounting frame by pressing and turning it clockwise.

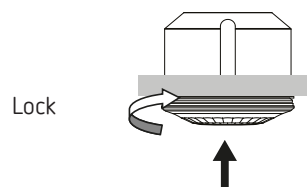

Dismounting and settings at the potentiometers

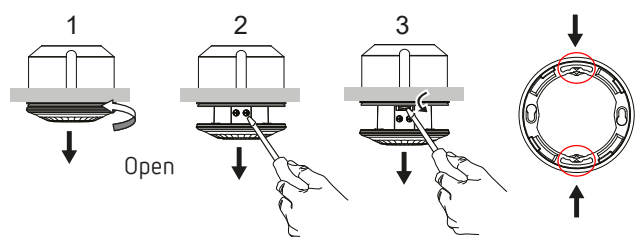

- Push the device upwards and turn it anticlockwise (1).
→ The device comes halfway out of the box.
- Make settings on the potentiometers (2); remount the device by pressing and turning it clockwise.
- For complete dismounting, press on a snap-in point (see arrow) above the potentiometers by using the screwdriver and loosen the device (3).

⚠ Pay attention to live parts.

Surface mounting

① This type of installation applies to detectors 1030062 / 1030162, 1030063 / 1030163, 1030082 / 1030182.

- Strip the cable to 8 – 10 mm according to the device labelling.

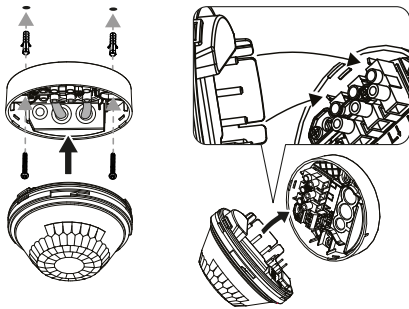

- Pierce the seal(s) for the lines in the surface-mounted housing with the screwdriver.
- Attach the housing to the ceiling and connect according to the terminal labelling.
- Attach the sensor part as shown and snap it into place by pressing.

- ① When mounting the sensor part, only press on the edge area.
- Place the decorative ring according to the marking and snap it into place by turning it.
- ① If cover clips are needed to restrict the detection area, they must be snapped onto the lens before mounting the decorative ring (see chap. Limiting the detection area, p. 4)

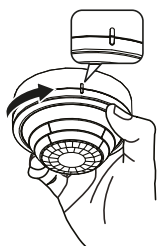
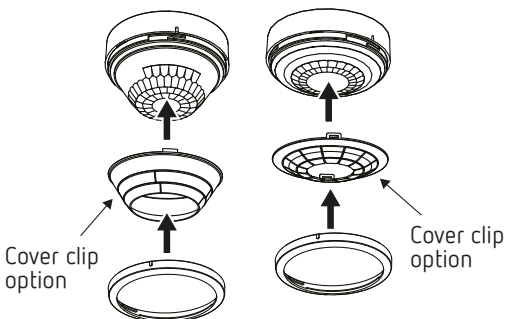

Surface-mounting with surface-mounted frame

If you wish to use the optional surface-mounted frame in grey or black (9070483, 9070484) with detector 1030063 / 1030163, you must proceed as follows:

- Loosen the screws of the terminal holder (1).
- Remove the terminal holder and connector of the S/P input (2, 3).
- Reinsert the connector for the HVAC channel and terminal holder for the push button/parallel input (H1, H2, S/P) and tighten the screws (4, 5, 6).

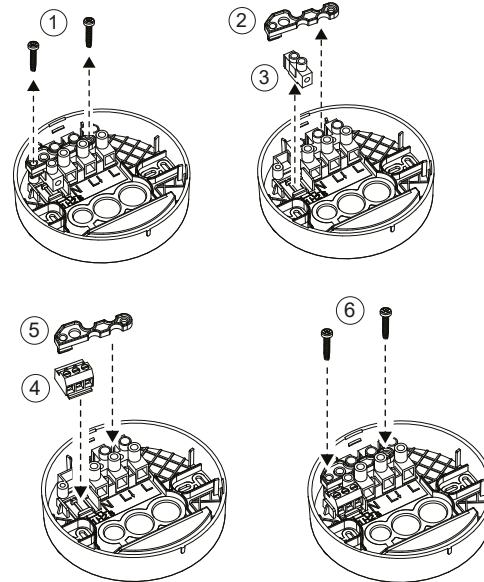

Dismounting

⚠ Ensure absence of voltage at the device.

- Dismount the decorative ring by turning it.
- Optionally, dismount the cover clip.
- Use the screwdriver to remove the sensor part from the surface-mounted housing at the points marked with an arrow.

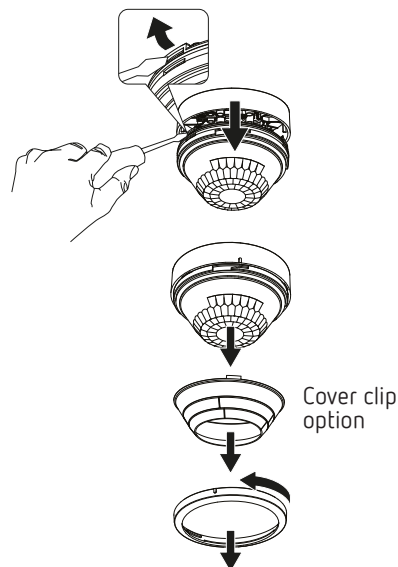

Indoor detection area

Presence detector (circular detection area)

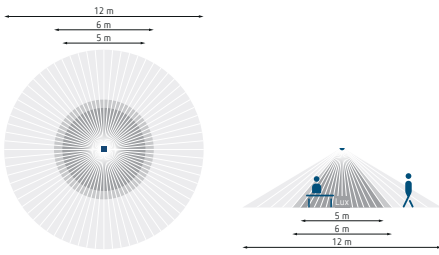

- going transversally to the detector
 - seated
 - going frontally to the detector
- Installation height: 3 m

Installation height (A)	going transversally (T)	going frontally (R)	seated (S)
2.5 m	∅ 10 m	∅ 6 m	∅ 4 m
3 m	∅ 12 m	∅ 6 m	∅ 5 m
3.5 m	∅ 10 m	∅ 6 m	∅ 5 m
4 m	∅ 10 m	∅ 6 m	–
6 m	∅ 12 m	∅ 6 m	–

Corridor detector (rectangular detection area)

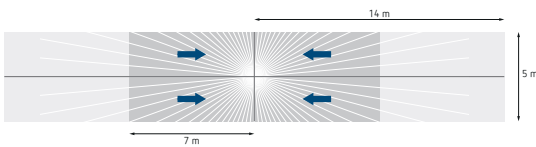

- going transversally to the detector
 - going frontally to the detector
- Installation height: 3 m

Installation height (A)	going transversally (T)	going frontally (R)
2.5 m	28 x 5 m	14 x 5 m
3 m	28 x 5 m	14 x 5 m
3.5 m	26 x 4 m	12 x 5 m

Limiting the detection area

- Use the enclosed cover clip to adjust the detector to the desired detection area.
- Remove the required section of the clip using scissors.
- Then place it on the lens.

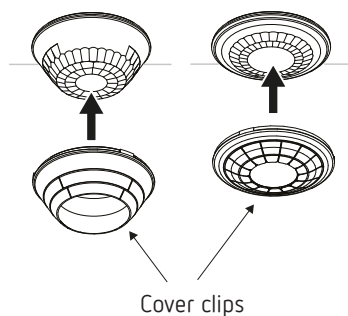

Presence detector

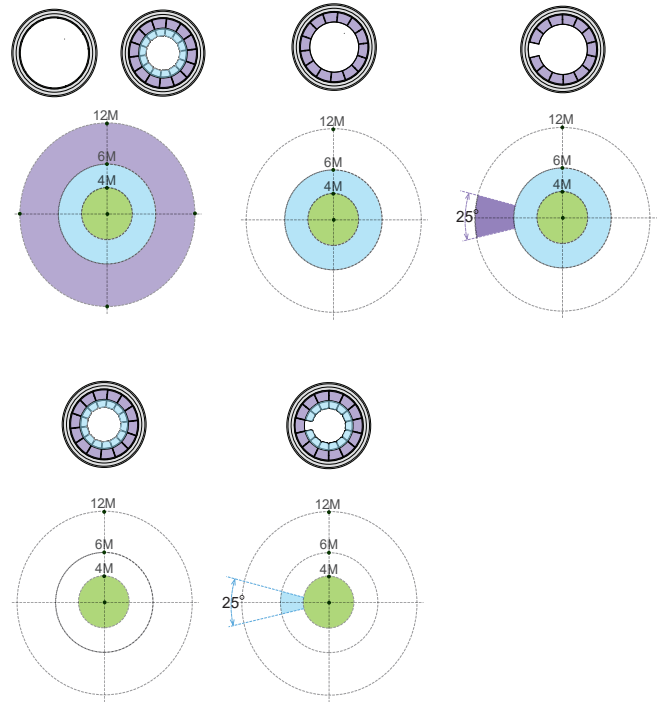

Corridor detector

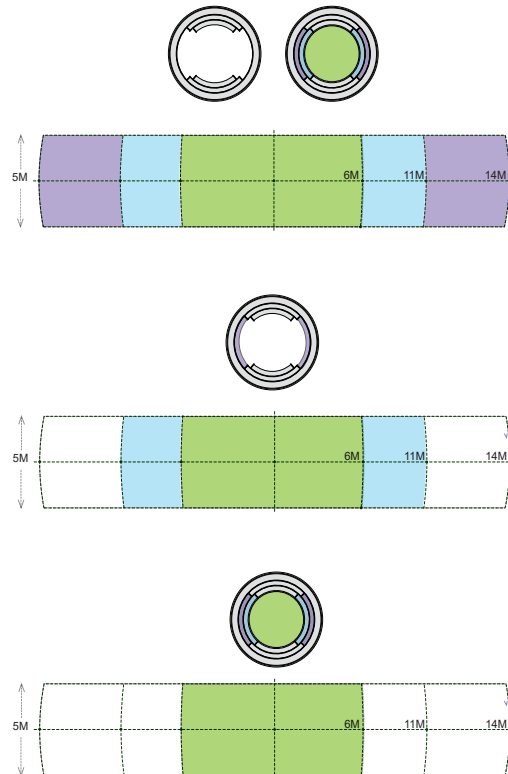

Outdoor detection area

LUXA 103 can also be used outdoors. This can be set in the app.

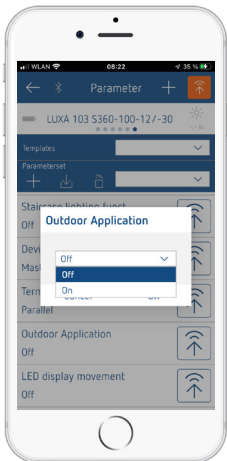

- ① Activating the "Outdoor application" reduces potential sources of interference, such as rain or wind. As a result, the detection area will be reduced.

Presence detector

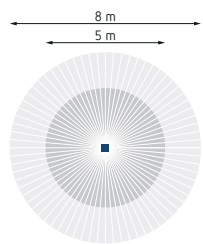

- going transversally to the detector
- going frontally to the detector

Installation height: 3 m

Corridor detector

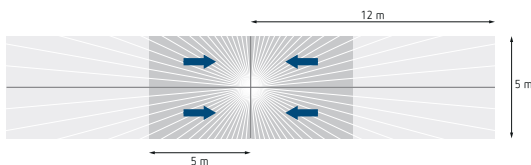

- going transversally to the detector
- going frontally to the detector

Installation height: 3 m

5. Connection

- ⚠ Use the same phase for all detectors and push buttons.
- ⚠ Illuminated push buttons can only be used with a neutral conductor connection.
- ⚠ Secure the device with an upstream type B or type C circuit breaker (EN 60898-1) of 10 A.
- ⚠ Secure the device with an upstream type B or type C circuit breaker (EN 60898-1) with a maximum of 6 A (H1/H2).
- ⚠ The S/P terminal can be used for 2 different applications:
 1. Push button input (factory setting)
 2. Parallel input for parallel switching with other devices (area extension) (programming via the Senda B and the Senda Plug app)

Individual switching

In individual switching, the presence detector detects presence and brightness and controls lighting.

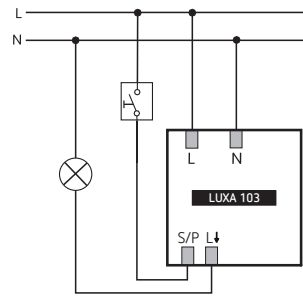

1030052/1030152
1030062/1030162
1030072/1030172
1030082/1030182

Presence detectors with additional HVAC contact control the lighting depending on presence and brightness, as well as connected HVAC devices depending on presence.

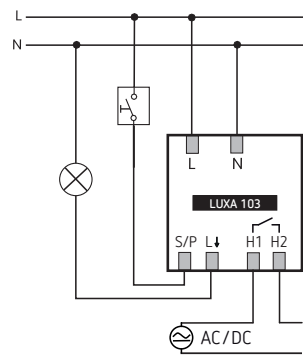

1030053/1030153
1030063/1030163

Parallel switching for area extension

If the detection area covered by a single presence detector is insufficient (in large rooms), then several detectors can be operated in parallel by connecting the S/P and L↓ terminals. For this purpose, the L↓ output of the parallel devices will be wired to the S/P terminal of the load-switching device. Presence detection occurs jointly in all detectors, brightness measurement exclusively in the load-switching device.

- Configure parallel devices as a parallel device via the Senda B and the Senda Plug app (see p. 9).
- Configure the S/P terminal of the load-switching device to "Parallel" by using the Senda B and the Senda Plug app (see p. 9).

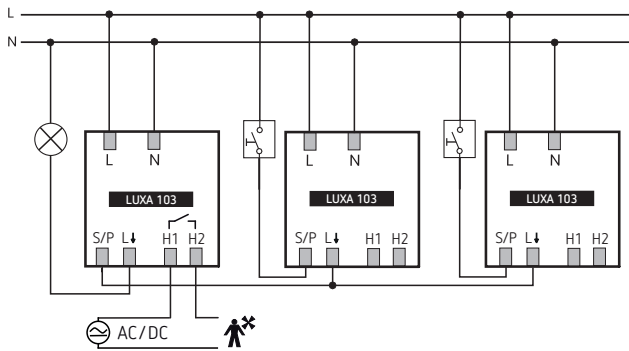

① A maximum of 8 devices can be operated in parallel.

Push button input

The push button can be used to switch the lighting on/off manually at any time (factory setting).

Switching on manually

Pressing the push button briefly switches the light on for max. 30 minutes, as long as motion is detected. If no more motion is detected within 30 minutes or the 30 minutes have elapsed, the detector switches back to automatic mode.

Switching off manually

If the light is switched on, it can be switched off for 30 minutes by briefly pressing the push button (as long as motion is detected). If no more motion is detected within 30 minutes or the 30 minutes have elapsed, the detector switches back to automatic mode.

Staircase light function

The so-called staircase light function is used for the lighting in the staircase. The light cannot be switched off via a push button (programmable only via the Senda B and the Senda Plug app).

Fully or semi-automatic

Lighting control via the presence detector operates fully automatically or semi-automatically. As a "fully automatic device", the lighting is switched on and off automatically (depending on the parameters set). As a "semi-automatic device", the detector has to be activated via a connected push button. It is then controlled and switched off depending on motion and brightness. The remote control is used to make the settings.

Switch-on behaviour

When the power supply is switched on or the device is restarted using the remote control, the presence detector runs through two phases that are shown by an LED and the connected lamp:

1. Warm-up phase (approx. 45 s)

- The red LED lights up and the light switch contact is closed (light on).
- The detector does not respond to push button commands and remote control commands.

2. Operation

- The detector is on standby (LED off) and the light switch contact opens when no one is present (light off).

6. Settings via potentiometer

On the 1-channel version (1030052/1030152, 1030062/1030162, 1030072/1030172, 1030082/1030182) the presence detectors have 2 potentiometers, and on the 2-channel version (1030053/1030153, 1030063/1030163) 4 potentiometers.

Example of presence detector with 1 channel

① applies to 1030052/1030152, 1030062/1030162, 1030072/1030172, 1030082/1030182

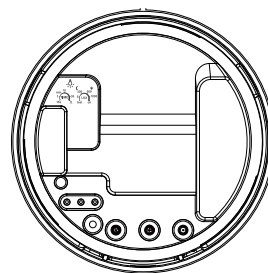

Light (channel 1) —
 — TIME
 — LUX

Example of presence detector with 2 channels

① applies to 1030053/1030153, 1030063/1030163

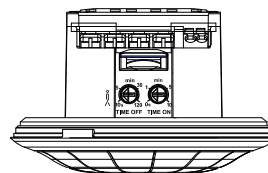

Light (channel 1) —
 — TIME
 — LUX

HVAC (channel 2) —
 — TIME OFF
 — TIME ON

Setting the brightness (LUX)

You can set different brightness values with the potentiometer for brightness (factory setting 300 lx for corridor sensors/500 lx for presence detectors).



- Set potentiometer to desired switch-on brightness (5 – 1000 lux/on).

On the **on** setting, the detector always responds to motion, regardless of the brightness.

Brightness measurement

The presence detector measures the surrounding brightness below the detector. The installation location is the reference point for the lighting level. If the brightness measurement is deactivated, the switch contact light only switches depending on presence (with the Senda B/app: brightness switching value set to "measurement off" via the remote control; with the Senda P: button "Lux On" activated).

- ① The brightness measurement value is influenced by the installation location, the incidence of light, the position of the sun, the weather conditions and by the reflection properties of the room and furniture. Therefore, the lux values are guide values.

Setting the time delay (TIME)

If the detector detects no further motion, it switches off after the set time delay. If you want to change the preset time (factory setting 10 min):



- Set the potentiometer to the desired time (e.g. 15 s, 1 min, 5 min, 10 min, 30 min).

If you wish to use the pulse function (e.g. for a staircase light timer switch):

- Set the potentiometer to \perp (0.3 s on, 10 s off).

Testing the detection area (test mode or walking test)

The test mode is used to test the detection area and to restrict it if necessary.

- Set the LUX potentiometer to **test**.
 - The presence detector only responds to motion; brightness measurement is switched off.
 - After the detector has detected a motion, it switches the connected light on for the shortest time delay (15 s). At the same time, the red LED on the detector lights up for the duration of the detected motion.

- ① If the test mode is activated via the potentiometers, it must also be deactivated via the potentiometers. In this case, remote control commands are not accepted during test mode.

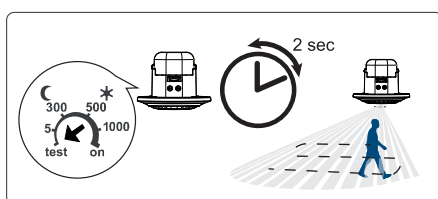

- ① If the walking test is carried out using the parallel device, the test mode must also be activated on the master device.
- ① Test mode can also be activated with the theSenda P remote control and the theSenda B/app (see also chap. Test detection range (test mode or walking test)).

7. Parameters and control commands via remote control

The following parameters can be checked or changed via the remote control for support during start-up as well as servicing:

Parameters

Parameters	theSenda B/ app check	Can be changed by theSenda B/ app	Can be changed by theSenda P
Brightness setpoint value A	X	X	X
Brightness actual value A	X		
Time delay A		X	X
Channel function H		X	
Time delay H		X	X
Switch-on delay H		X	
Configuration type		X	X
Staircase light function		X	
Terminal S/P assignment		X	
Device function		X	
LED motion display		X	

- ① The parameters are sent to the detector by infrared. Changed parameters are applied and used. The red status LED flashes briefly to confirm that the device has received and understood the infrared commands.

To check the parameters:

- press the and follow the instructions in the app.

Control commands

The following control commands can be triggered with the remote control:

Control command	Can be triggered by theSenda B/app	Can be triggered by theSenda P	Can be triggered by theSenda S
Teach-in channel A	X	X	
Switching light	X	X	X
Detection area test	X	X	
Restart	X	X	
Factory settings	X		

Connecting a mobile device to the theSenda B/app remote control

- Open the theSenda Plug app.
- Press the Bluetooth symbol in the app on the top left-hand side.
- Briefly press the Bluetooth button on the theSenda B.
 - LED flashes red, devices are searched for.
- Confirm with OK.
 - LED lights up red and the Bluetooth icon in the app changes colour from grey to blue.

8. Parameters and control commands via app

1. Parameters

Brightness setpoint A



theSenda Plug



theSenda P

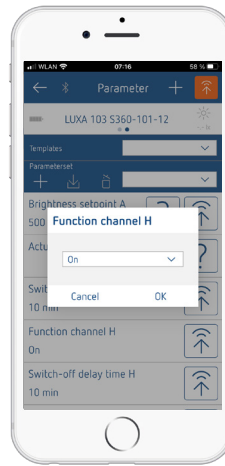

Switch-off delay time H

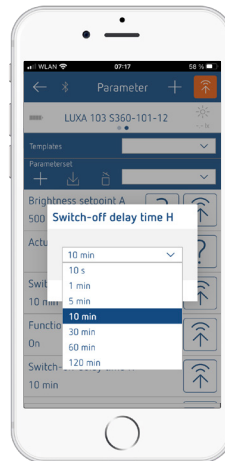

theSenda Plug

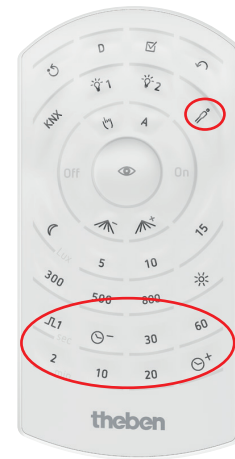

theSenda P

Actual brightness A

Checking the currently measured actual brightness value.

► Follow the instructions in the app.

Switch-off delay time A



theSenda Plug



theSenda P

Switch-on delay time H

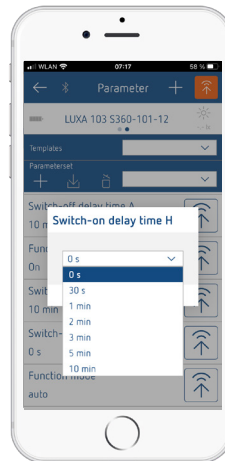

Function mode

auto = fully automatic

The lighting switches on and off automatically (based on presence, absence and brightness)

man = semi-automatic

The lighting is always switched on manually via the push button. It is switched off by the detector.

Function channel H

Channel H (potential-free contact), e.g. for controlling a fan in the bathroom, switches on when presence is detected (regardless of brightness), regardless of whether the configuration type is set to **man** or **auto**. This function can also be deactivated.



theSenda Plug



theSenda P

Terminal S/P assignment

The S/P terminal can either be connected to an external push button or used for parallel switching of devices ("Parallel").

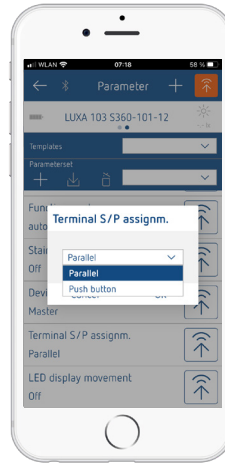

LED display movement

Motion detection is indicated by the LED.

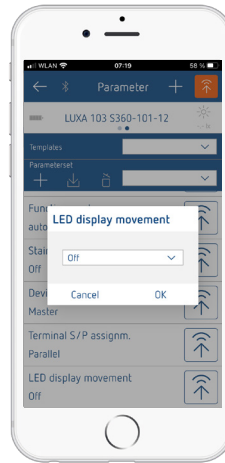

Staircase lighting function

With the **off** staircase lighting function the light can be switched on and off manually using the push button at any time. With **on** it can be switched on manually but not switched off. The light will not be switched off again until after the set time delay.



Device function

If a device is wired in parallel to a load-switching device, the device function in the parallel-wired device must be changed from master (factory setting) to parallel device via remote control and app.



2. Control commands

Teach-in channel A

The detector saves the current surrounding brightness as the new switch-on brightness.

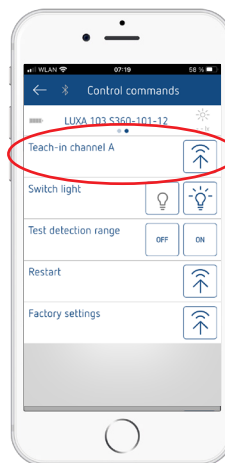

theSenda Plug

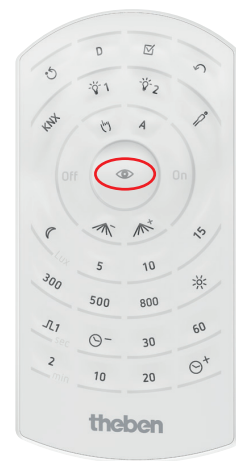

theSenda P

Switch light (on/off)

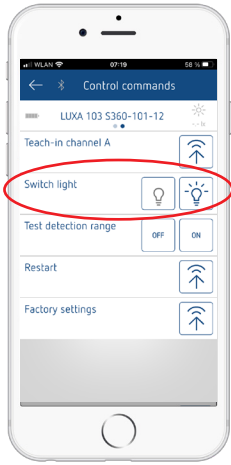

theSenda Plug



theSenda B

Restart

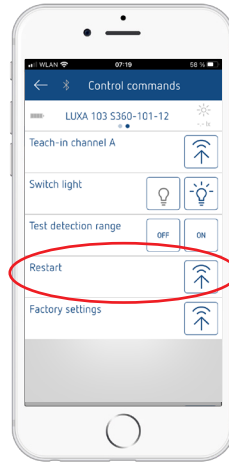

theSenda Plug



theSenda P



theSenda P



theSenda S

Factory settings

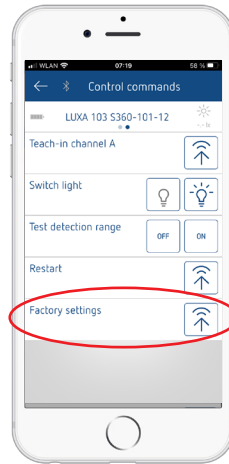

Factory settings

Parameters	LUXA 103
Brightness setpoint value A	300 lx/500 lx
Time delay A	10 min
Channel function H	On
Time delay H	5 min
Switch-on delay H	1 min
Configuration type	Auto
Staircase light function	Off
Device function	Master
Terminal S/P assignment	Push button
LED motion display	Off

Test detection range (test mode or walking test)

- Select ON in the app.
 - The detector always responds to motion (regardless of brightness and configuration type).
 - After the detector has detected a motion, all contacts switch on for the shortest possible time delay.
 - The red LED lights up.



theSenda Plug



theSenda P

Switch-on behaviour

- Warm-up phase (approx. 45 s) after restoration of power
- The red LED flashes at one second intervals, the light switch contact is closed.
 - The detector does not respond to push button commands and remote control commands.
 - If no one is present, the contact opens after the end of the warm-up phase.

Operation

- The detector is ready for operation (LED off).

- ① The test mode ends after 10 min if it was activated via remote control.

- ① The test mode can be ended by selecting another operating mode (fully automatic/semi-automatic).

LED display

LED	Description
flashes slowly	The presence detector is in warm-up phase.
Flashes rapidly	The command sent from the remote control via infrared was accepted by the presence detector.
lights up briefly	The command sent from the remote control via infrared was rejected by the presence detector. The command is not valid. Check the selected detector type or parameters in the app.
lights up or flickers irregularly	The presence detector is in presence test mode or "LED motion display" is activated. The LED displays detected motion.

Troubleshooting

Fault	Cause
Light does not switch on or off if presence is detected and in darkness	Lux value is set too low; detector set to semi-automatic; light was switched off manually via push button or remote control; person not within detection area; obstruction(s) interrupting detection; time delay set too short
Light stays on with detection of presence despite sufficient brightness	Lux value is set too high; light was briefly switched on manually via push button or remote control (wait 30 min); detector is in test mode
Light does not switch off, or light switches on spontaneously when no one is present	Thermal sources of interference in the detection area: fan heaters, incandescent lamps/halogen spotlights, moving objects (e.g. curtains hanging in open windows); load (EBs, relays) not cleared
Push button does not work	Device still in the warm-up phase; illuminated push button was used without neutral conductor; Push button not connected to the device
Light cannot be switched off with the push button	Push button is not connected to the detector. Check the push button wiring, staircase light function activated
Device does not respond	Short circuit or several phases in parallel switching! Disconnect detector from the power supply for 5 min (thermal fuse)
Light flashes briefly every 10 s	Parallel device is connected, but the load-switching device is not programmed as a master
Device does not respond to changing brightness conditions	Device is programmed as a parallel device

9. Technical data

Operating voltage	230 V AC, + 10% / - 15%
Frequency	50 – 60 Hz
Standby output	approx. 0.5 W
Max. switching capacity	10 A (at 230 V AC, $\cos \varphi = 1$)
Min. switching capacity	10 mA
Switching capacity H1/H2	50 W/50 VA (max. 2 A)
Operating temperature	-25 °C to + 55 °C
Brightness setting range	5 – 1000 lx/on
Duty cycle range	Lighting channel: 15 s – 30 min; HVAC channel: switch-on delay → 0 s – 10 min; time delay → 10 s – 120 min
Inrush current	max. 500 A/200 μ s
Detection angle	360°
Detection area	going transversally: \varnothing 12 m going frontally: \varnothing 6 m, presence: \varnothing 5 m corridor: 5 x 28 m
Installation height	2.5 – 6.0 m
Contact	μ contact 240 V AC (NO contact)
Incandescent lamp load	2300 W
Halogen lamp load	2300 W

Fluorescent lamps (LLB low-loss ballasts): uncompensated series compensated parallel compensated	1150 VA 600 VA 400 W
Fluorescent lamps (EB – electronic ballasts)	600 W
Compact fluorescent lamps (EB)	150 W
LED lamps	400 W ($\cos \varphi \geq 0.9$)
Protection rating	1030052/1030152, 1030053/1030153, 1030072/1030172: IP 20 (IP 54 when installed) 1030062/1030162, 1030063/1030163, 1030082/1030182: IP 54
Protection class	II subject to designated installation
Software	Class A

Cleaning and service

- Only use a dry, soft cloth to clean the device surface.
- Do not use any cleaning agents or solvents.

Disposal



Dispose of the device separately from domestic waste at an official collection point.

Dimensions diagrams

Presence detector

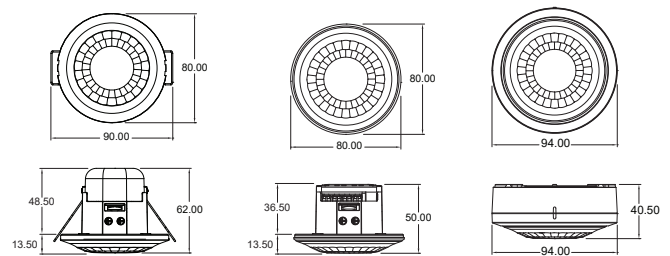

Corridor detector

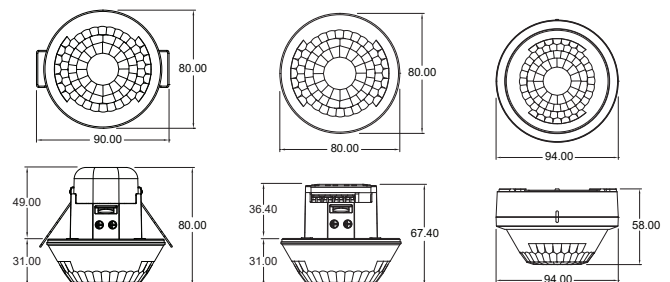

10. Contact

Theben AG
Hohenbergstr. 32
72401 Haigerloch
GERMANY
Phone +49 7474 692-0
Fax +49 7474 692-150
Technical Support
Phone +49 7474 692-369
techsupport@theben.de
www.theben.de