

theben

EN Time switch

TR 611 top2 RC 24 V
6114300



307096

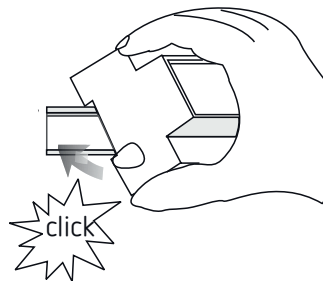

1. Basic safety information



WARNING

Danger of death through electric shock or fire!

➤ Installation should only be carried out by a qualified electrician!

- The device is designed for installation on DIN top hat rails (in accordance with EN 60715)
- The device corresponds to type 1 BSTU in accordance with IEC/EN 60730-2-7
- Power reserve (10 years) is reduced if memory card is inserted (using battery power)

! OBELISK top2 memory card: Avoid mechanical overload and contamination during storage/transportation

2. Proper use

- The time switch is used for lighting, ventilation and flushing applications etc.
- Only for use in closed, dry rooms

! Do not use on safety devices, e.g. escape route doors, fire safety equipment etc.

Disposal

➤ Dispose of device in environmentally sound manner

3. Installation and connection

Mounting the time switch



WARNING

Danger of death through electric shock or fire!

➤ Installation should only be carried out by a qualified electrician!

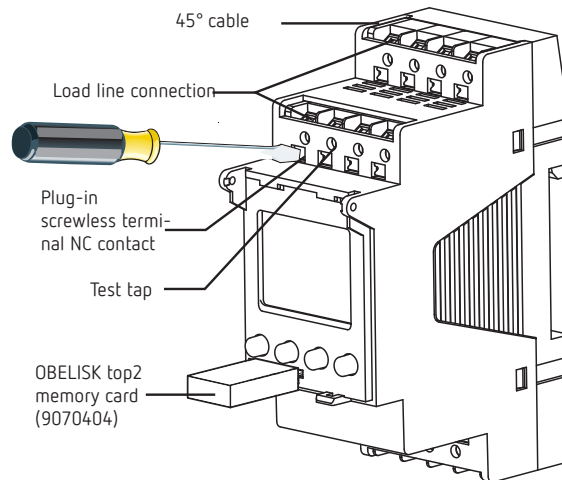

- Mount on DIN top hat rails (as defined in EN 60715)
- Switched voltage-free
- Ensure device cannot be switched on
- Check absence of voltage
- Earth and bypass
- Cover or shield any adjacent live components

① Best reception is achieved by installing the antenna on the outside of the building

Connecting the cable

Wiring diagrams

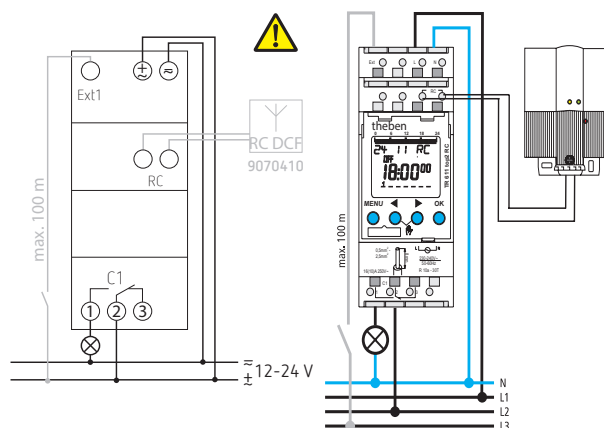

① Ensure correct polarity.

① Lay separate cable for antenna power supply.

① Align the radio antenna so that the green LED flashes once a second.

① A maximum of 10 devices can be connected to one antenna.

- Strip cable to 8 mm (max. 9)
- Insert cable in the open DuoFix® plug-in terminal at 45°
 - ④ 2 cables per terminal position possible
- To open the DuoFix® plug-in terminal, press screwdriver downwards

Disconnecting the cable

- Use the screwdriver to push the load line connection opener downwards

4. Device description

Display & buttons

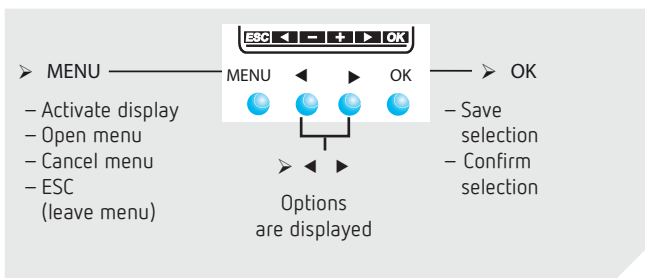
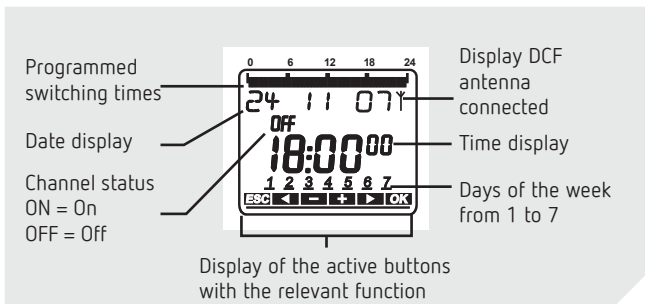

Operating instructions

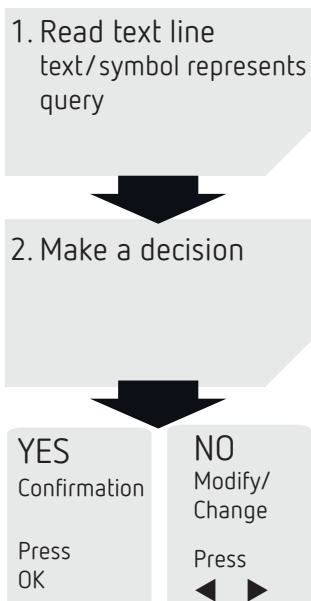

Overview of navigation menu

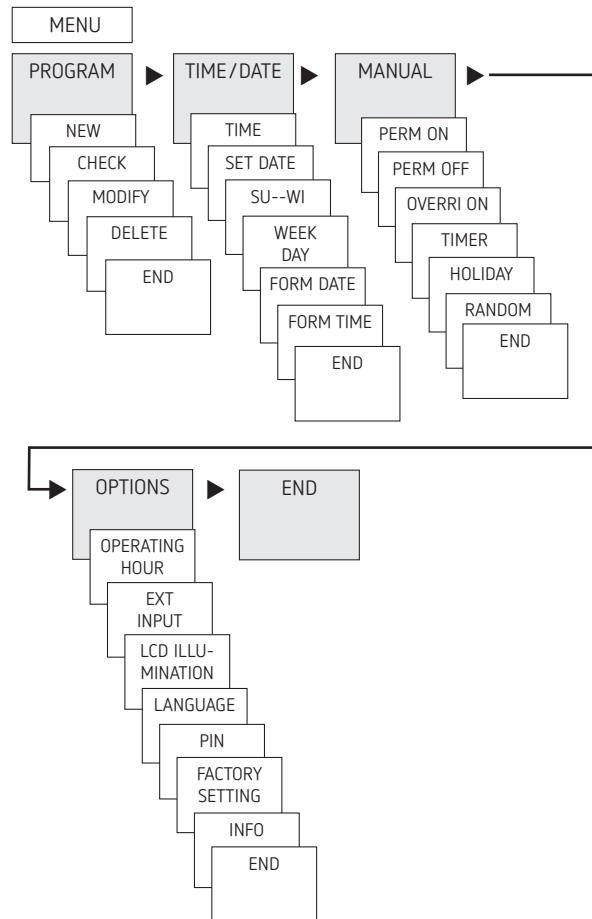

Initial operation

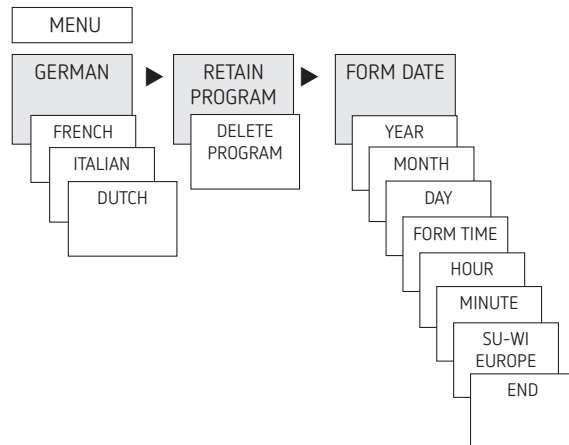

- Set language, country, town/city, date, time as well as summer/winter time (SU-WI)
- Press any button and display follows on screen (see figure)

5. Settings and functions

Set switching time

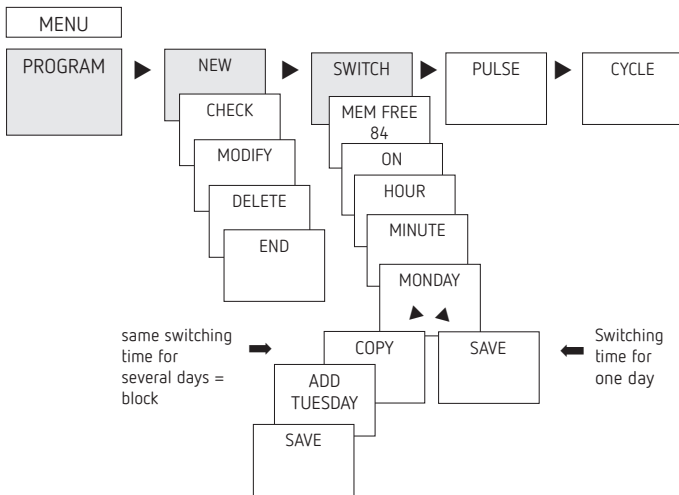

① A switching time always consists of a start time and an end time

① There are 84 memory cells available

Example: Switch on sports hall lighting from Mon–Fri, 7:30 to 12:00 hrs

- Press MENU
- Select PROGRAM and press OK to confirm
- Select NEW and press OK to confirm
- Select SWITCH, confirm by pressing OK
- Select ON (for turn-on times), confirm with OK
- Set required turn-on time (Mo–Fr, 7:30), confirm with OK
- Select COPY, confirm with OK
- ADD TUESDAY is displayed, confirm by pressing OK and also confirm the days We, Th, Fr by pressing OK.
- Continue with ► until SAVE is displayed.
- Confirm by pressing OK.

Repeat all steps for the turn-off time, however instead of selecting ON with ► select OFF and enter 12:00 for hour and minute.

Change switching times

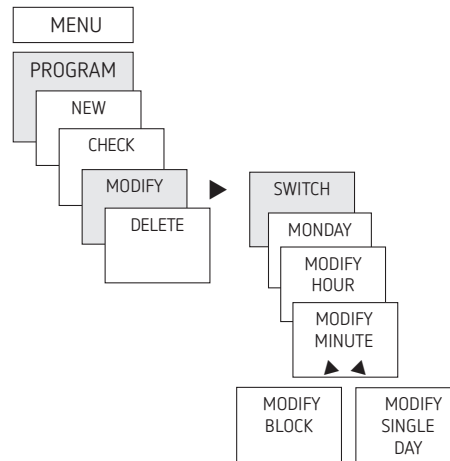

① You can either change or delete a block, i.e. a switching time copied for several days (e.g. Mon–Fri) or a single switching time

Change individual switching times

- Press MENU
- Select PROGRAM and press OK to confirm
- Select MODIFY, confirm by pressing OK
- Select SWITCH, confirm by pressing OK
- Select day, confirm with OK
- MODIFY HOUR, use the + or – buttons to change hour and minute and confirm with OK.
- To change several switching times, select MODIFY BLOCK, confirm with OK

Delete switching program

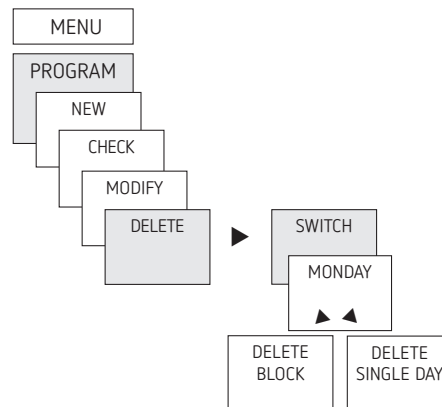

① You can either delete a block, i.e. a switching time copied for several days (e.g. Mon–Fri) or a single switching time

- Press MENU.
- Select PROGRAM and confirm with OK
- Select DELETE, confirm with OK
- Select SWITCH, confirm with OK
- MONDAY is displayed, confirm with OK
- Select DELETE BLOCK, confirm with OK
- With ► DELETE MONDAY etc. individual days can also be cleared.

Pulse programming

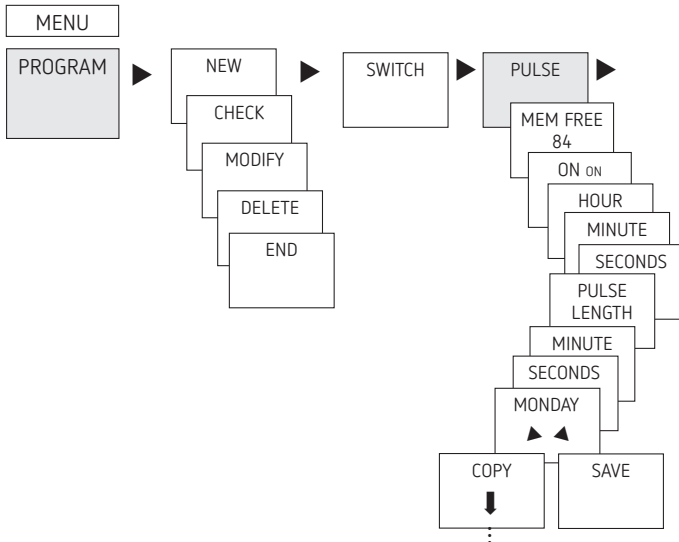

Example: Switch on pause signal on Monday 8:05 hrs for 5 sec

- Press MENU
- Select PROGRAM, confirm with OK
- Select NEW, confirm with OK
- With ► select PULSE, confirm with OK
- Select ON, confirm with OK
- Use the + or – buttons to enter hour, minute, second (8:05) and confirm with OK
- Use the + or – buttons to enter the duration of the pulse in minutes and seconds (5 sec) and confirm with OK. MONDAY is displayed.
- Select day, confirm with OK
- Select COPY or SAVE
- To save press ► and confirm with OK
- To copy press OK

Cycle programming

In addition to turn-on and turn-off times (switching time) and short time pulses (pulse) cycle times (cycle) can also be programmed. The pulse duration (+ pulse pause) is limited to 17 hrs, 59 min, 59 sec

- ① Cycle times refers to cyclically repetitive time functions such as fan controls, urinal rinses etc.

Example: Switch on water rinsing Monday from 8:00 to 20:30 hrs every 15 min for 20 sec (8:00:00–8:00:20 On; 8:15:00–8:15:20 On; 8:30:00–8:30:20 On etc.)

Cycle programming:

- Start cycle: Monday 8:00 hrs
 - Pulse duration: 20 s
 - Pause duration (pause): 14 min and 40 s
 - End cycle: Monday 20:30 hrs
- ① Observe the number of maximum electrical switching cycles when using the cycle function.

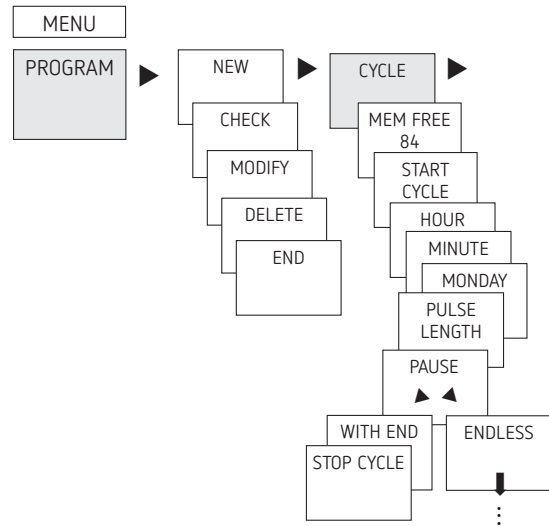

- Press MENU
- Select PROGRAM, confirm with OK
- Select NEW, confirm with OK
- With ► select CYCLE, confirm with OK
- START CYCLE is displayed, confirm with OK
- Use the + or – buttons to enter hour, minute, day (8:00 hrs Monday) and confirm with OK
- Enter PULSE LENGTH (20 s), confirm with OK
- Enter pause duration PAUSE (14 min and 40 s), confirm with OK
- Select WITH END, confirm with OK
- STOP CYCLE is displayed, confirm with OK
- Enter end times of the cycle (20:30 hrs) and confirm with OK

Setting holiday function

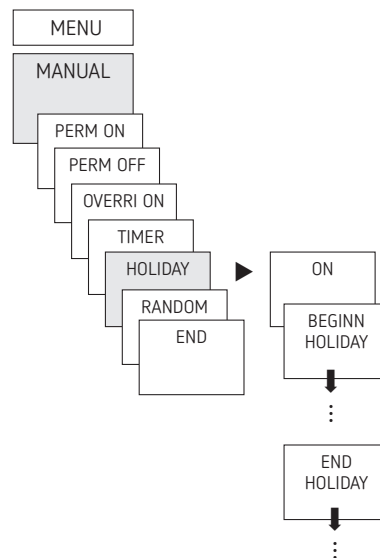

- Press MENU
- Select MANUAL and press OK to confirm
- Select HOLIDAY and press OK to confirm
- Select ON and press OK to confirm
- Select START HOLIDAY and press OK to confirm
- Enter YEAR, MONTH, DAY, HOUR and press OK to confirm
- Select END HOLIDAY and press OK to confirm
- Enter YEAR, MONTH, DAY, HOUR and press OK to confirm

Activating PIN code

The PIN code is set in OPTIONS via the menu.

- ① If you have forgotten your PIN, call the Theben Hotline.
- ① Have the serial number ready

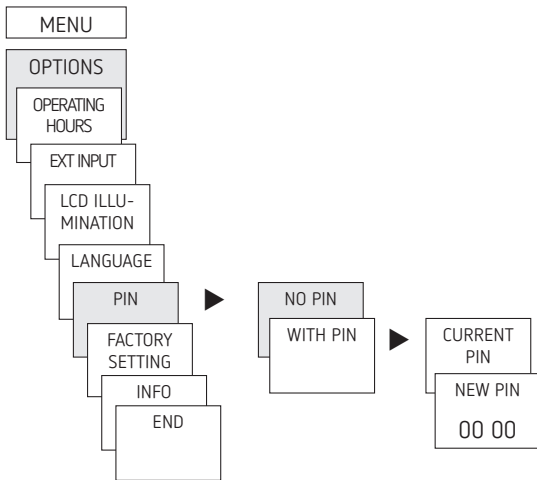

Time signal can be received with appropriate top2 RC antenna

- ① Follow advice in the top2 RC-DCF antenna operating instructions.
- ① Connection to the top2 RC-DCF antenna allows the time switch to be automatically synchronised via DCF signal.
- ① After connecting to the power supply or resetting the automatic display changes as soon as the DCF transmission signal is received.

Setting time zones

After successful synchronisation, the time zone can be altered in the TIME/DATE menu option.

- In the TIME menu option (Indicating: ALTER HOUR) correct the applicable local time (time zone).

DCF transmission signal reception:
Indicating: Day + Month + RC
(Radio Control)

No connection to antenna:
Indicating: e.g. 24 11 07 Y

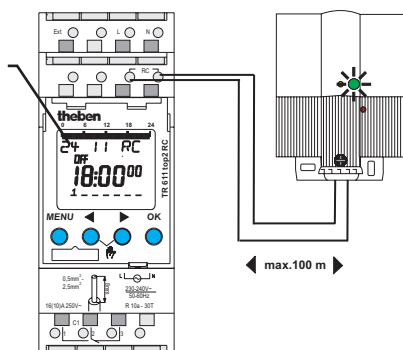

Setting manual or permanent switching

Manual or permanent switching can be set via the menu in MANUAL or (in the automatic screen) by button combination (see picture).

- Manual control:
Reversing the channel status to the next automatic or programmed switching.
- Permanent switching:
As long as a permanent switching (on or off) is activated, the programmed switching times are ineffective

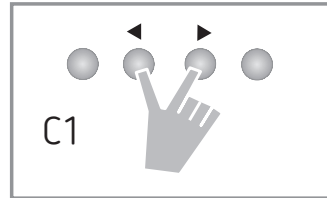

Activating manual control

- Briefly press both buttons simultaneously

Activating permanent switching

- Press both buttons simultaneously for 2 seconds

Cancelling manual/permanent switching

- Press both buttons simultaneously

Set external input

For the channel, an EXTERNAL INPUT (see figure) can be set with different functions.

3 sub-menus can be selected: Inactive, push button (function), switch (function)

- INACTIVE: The external input has no function
- PUSH BUTTON: Manual (manual control), Timer (count-down timer) are selectable
- SWITCH: Permanent On, permanent Off are selectable

- ① If a function is activated via an external push button or switch, EXTERNAL is displayed.

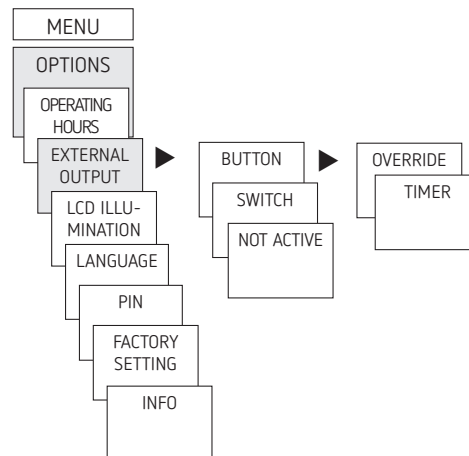

- Press MENU, with ► select EXT INPUT and follow the indications on the display.

Hour counter

The operating hours of the channel (relay) are displayed and deleted in the OPTIONS menu. If the number of operating hours exceeds the value set in the Service menu, SERVICE will appear in the display.

Example: Replace a lamp after after 5,000 h.

- Delete operating hours or set a higher value in Service (e.g. to 10,000 h)

Using the OBELISK top2 memory card

All functions can also be set on the PC using the OBELISK software and transferred to the device via the memory card.

- Insert memory card in the time switch
- Read in/out saved switching times and device setups in the time switch or start Obelisk program
- Remove memory card after copying etc.

⚠ Avoid mechanical overload and contamination during storage/transport

- ① PC software OBELISK top2 available at www.theben.de

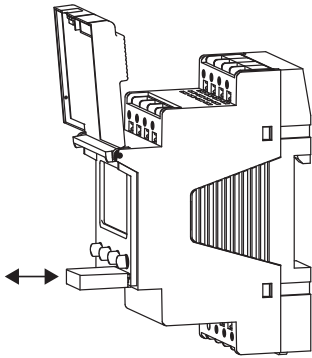

Copying OBELISK → TIME

This copies the switching program and optionally all time switch settings (e.g. external input, time format etc.) from the memory card in the time switch.

Copying TIME → OBELISK

This copies all switch programmes and settings from the time switch to the memory card.

Starting OBELISK program

Takes on the switching times that are programmed on the memory card.

As soon as the memory card is removed, the switching times of the time switch are re-activated.

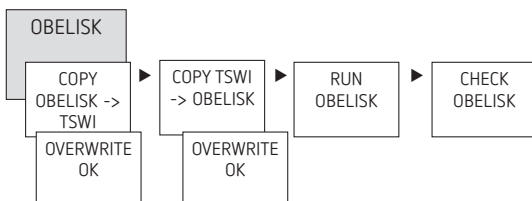

Resetting the time switch

- Press the 4 buttons simultaneously
→ You can choose between KEEP PROGRAM and DELETE PROGRAM

6. Technical data

Operating voltage:	12 - 24 V, +10 % / -15 % 12 - 24 V DC, +10 % / -15 %
Frequency:	50-60 Hz
Power consumption:	0,9 W - 1,3 W
Max switching capacity:	16 A (at 250 V, cos φ = 1)
switching capacity:	2 A (at 250 V, cos φ = 0,6)
Min. switching capacity:	10 mA/230 V AC 100 mA/ 24 V AC/DC
Shortest switching time:	1 second
Protection rating:	IP 20 in accordance with EN 60529
Protection class:	II in accordance with EN 60730-1 subject to designated installation for supply with FELV and/or mains switching
Protection class:	III for supply with SELV and switching of SELV
Operating temperature:	-30 °C ... +55 °C
Power reserve:	10 years at +20 °C
Time accuracy:	±0,25 s/day (25 °C)
Rated impulse withstand voltage:	4 kV
Pollution degree:	2
Contact:	two way switch
Glow lamp load (230 V):	1400 W
Halogen lamp load (230 V):	1400 W
Fluorescent lamp load: uncorrected	10000 VA 80 W (max. 12 µF)
Series corrected:	
parallel-corrected:	
Compact fluorescent tubes (EVG):	30 W
LED lamps (<2 W) (230 V):	6 W
LED lamps (>2 W < 8 W) (230 V):	20 W
LED lamps (> 8 W) (230 V):	20 W
Approved for switching SELV and mains voltage.	

7. Contact

Theben AG
Hohenbergstr. 32
72401 Haigerloch
GERMANY
Tel. +49 7474 692-0
Fax +49 7474 692-150

Hotline

Tel. +49 7474 692-369

hotline@theben.de

Addresses, telephone numbers etc.

www.theben.de