

EN Motion detectors

- theLuxe P220 WH 1010605
- theLuxe P220 BK 1010606
- theLuxe P300 WH 1010610
- theLuxe P300 BK 1010611

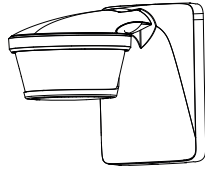

1. Basic safety information

WARNING
 Danger of death through electric shock or fire!
 ➤ Installation should only be carried out by a qualified electrician!

- The device conforms with EN 60669-2-1 if correctly installed
- IP 55/54 according to EN 60529 (depending on type of installation)

2. Proper use

- Motion detector for automatic lighting control dependent on presence and brightness
- Suitable for external wall or ceiling installation
- Suitable for entrances, garages, gardens, corridors, parks, etc.
- Only intended for installation outside of arm's reach

Disposal

- Dispose of device in environmentally sound manner.

3. Description

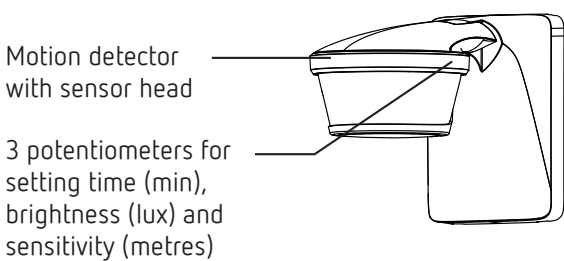

4. Connection

- Disconnect power source!
- Ensure device cannot be switched on!
- Check absence of voltage!
- Earth and bypass!
- Cover or shield any adjacent live components.
- D1, D2: Suited for switching FELV or a voltage of the same phases as L.

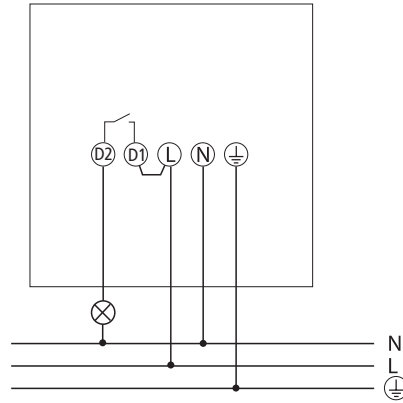

5. Installation

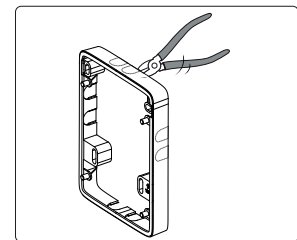
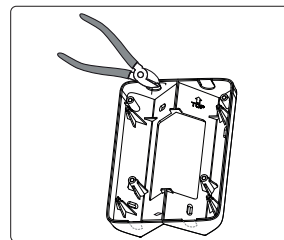
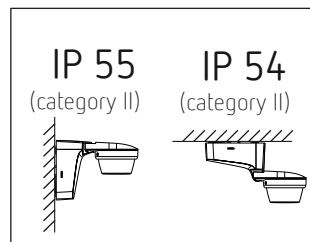

- If applicable, use optional corner bracket (9070904, 9070905) or spacer frame (9070908, 9070909) for flexible installation as well as cable entry from side or top/bottom.

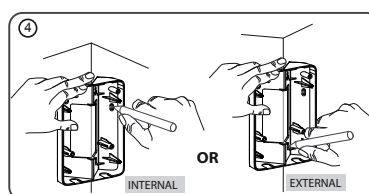
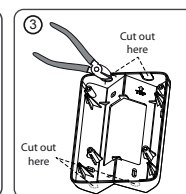
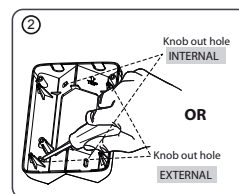
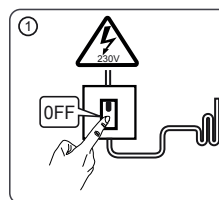

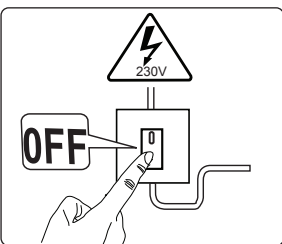
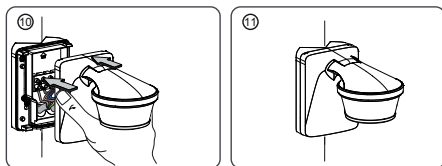
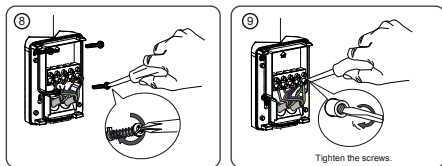
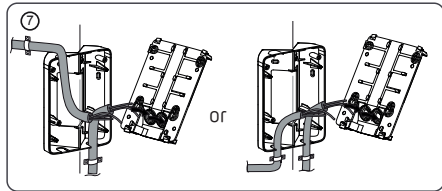
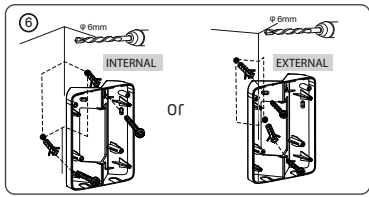
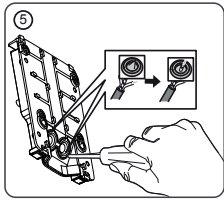

➤ Disconnect power source.

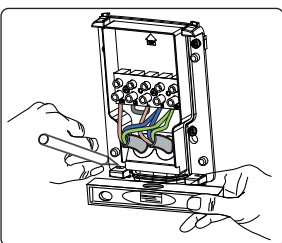

➤ Make marks for the holes on the wall (with enclosed drill template/base).
 ➤ Drill holes.

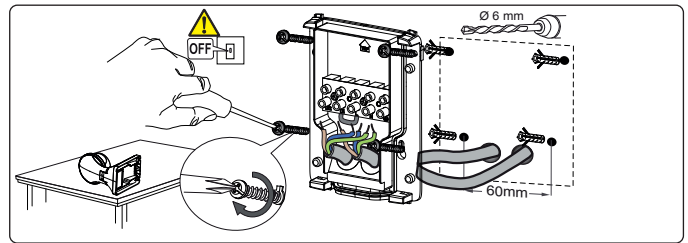

➤ Feed cable through the seal of the base.
 ➤ Fasten base (and spacer frame) to the wall.

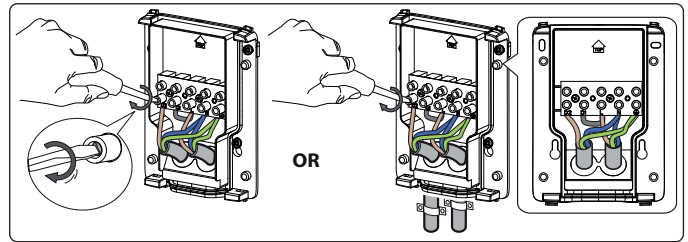

L	Phase	brown
N	Neutral conductor	blue
⊕	Earthing conductor	green/yellow

D1, D2	Relay contact	brown
N		blue
⊕		green/yellow

➤ Connect the individual wires to the appropriate terminal.
 ➤ Tighten screws.

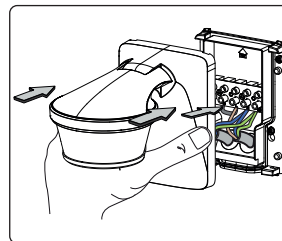

➤ Plug motion detector onto base and engage.

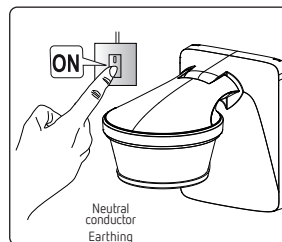

➤ Connect motion detector to power supply.

Dismounting

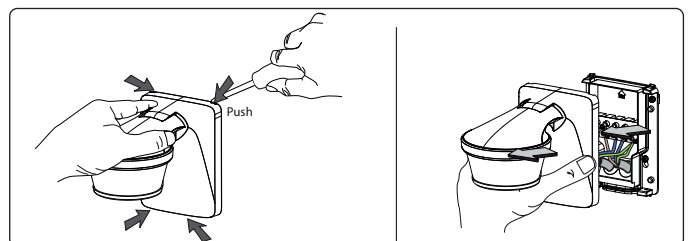

➤ Using the screwdriver, carefully loosen the upper and lower snap-fits and pull the device away in a forward direction.

Installation instructions

As the detector reacts to variations in temperature, avoid the following situations:

- Do not direct motion detectors at objects with highly-reflective surfaces such as mirrors, etc.
- Do not install the motion detector near heat sources, such as heating outlets, air conditioning systems, lamps, etc.
- Do not direct the motion detector at objects that move in the wind, such as curtains, large plants, etc.
- Pay attention to the direction of motion during the test run.

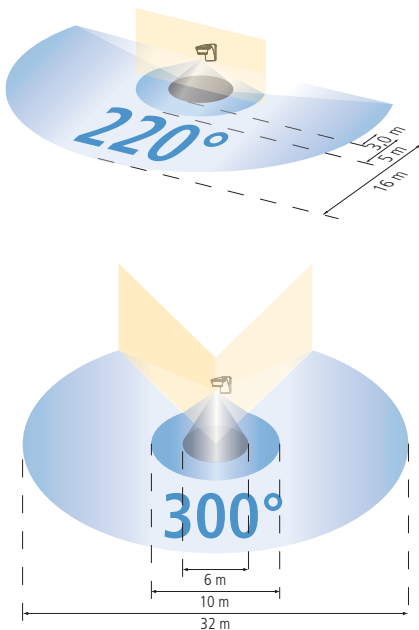
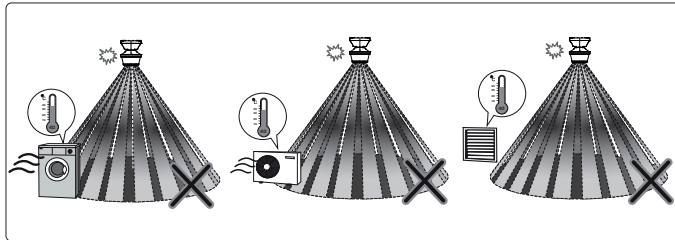

- Recommended installation height: 2 – 4 m
- Transverse detection area: 16 m (transversal to the detector)
- Frontal detection area: 5 m (directly approaching the detector)
- Detection angle: 220° or 300°

6. Walking test and alignment

The walking test is used to test the detection area and to restrict it if necessary.

- Set the potentiometer time (min) to test. The motion detector now only reacts to movements (independent of brightness).
- Walk through the detection area at a right angle. After the motion detector has detected a movement, it switches on for 2 s.
- Pay attention to the direction of motion during the test.

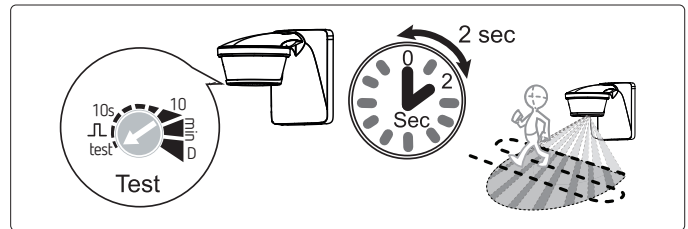

Align motion detector with sensor head

The sensor head can be turned by 45° downwards, 90° upwards, and 90° to the left and right.

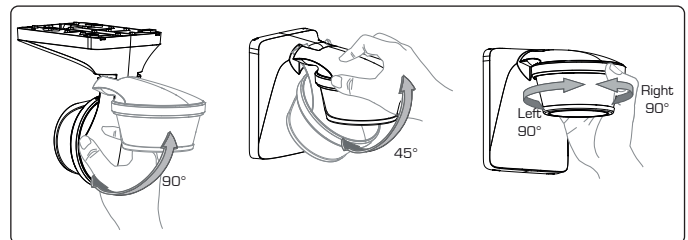

7. Using cover clips

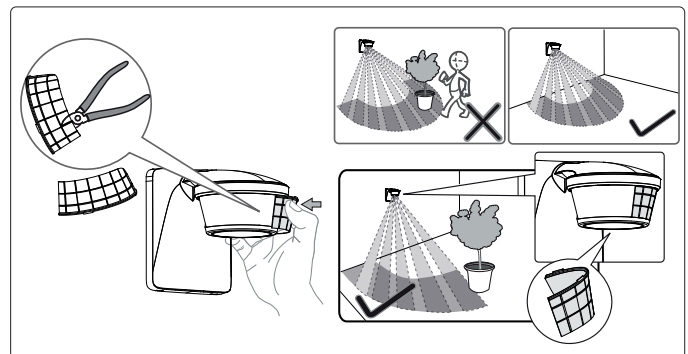

- Use the supplied clips, to adjust the motion detector to the desired detection area.
- Remove the required section of the clips by using pliers or the like.
- Then place on the lens and screw it in.
- When required, use the provided double sided adhesive tape for fastening the cover clips.

8. Setting

The motion detector has 3 potentiometers for setting time (min.), brightness (lux) and sensitivity (metres), etc.

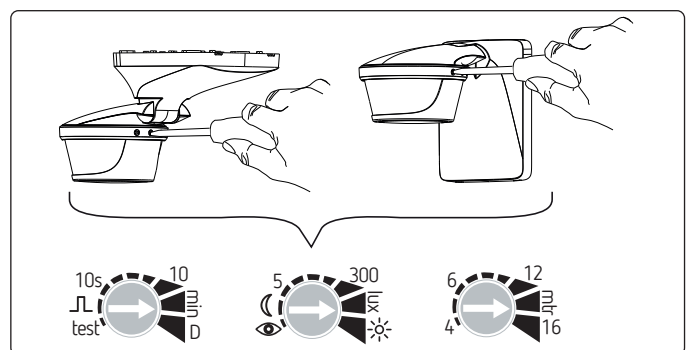

Setting the brightness (lux)

You can set different brightness values (lux) with the potentiometer.
If you want to change the preset brightness (15 lux default)

- set the potentiometer to the desired brightness (5 – 1000 lux)

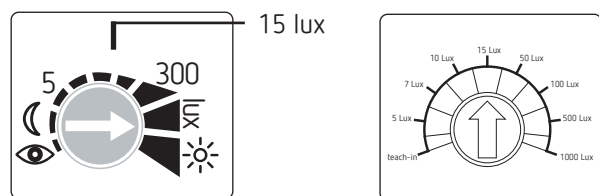

or want a specific brightness value to be learned using the teach-in function:

- At the desired brightness, set the potentiometer to . The new value will be learned after 15 s.
- Leave the potentiometer at position .

Setting the time (min)

If the motion detector detects no further movement, it switches off after the set time.

- If you want to change the preset time (2 min default)
- set the potentiometer to the desired time (1 s - 20 min).

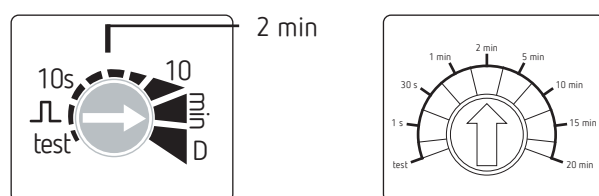

If you want to use the pulse function (e.g. for a staircase light timer switch)

- set the potentiometer to . The motion detector is switched on for < 1 s, then off for 9 s. If it detects a movement again, it switches on again for 1 s.

Setting "twilight switch" function D

- Set potentiometer to position D. Motion detector only reacts to brightness and is always on when the set brightness value has not been reached.

Setting the sensitivity (meters)

You can reduce the sensitivity; this also reduces the detection area.

- Set potentiometer metres to the desired sensitivity.

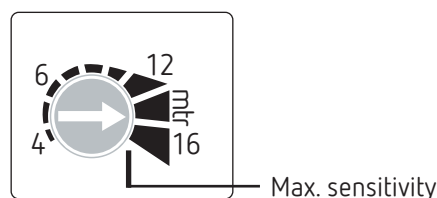

9. Settings with remote control

You can also enter the settings with remote controls theSenda P and theSenda S.

Settings using theSenda P (9070910)

The following parameters or functions can be set with theSenda P:

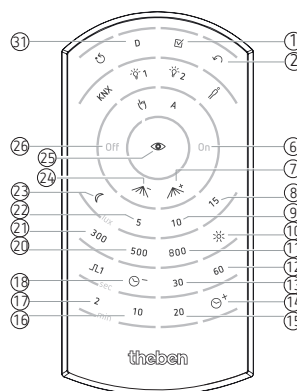

①	Test	Test mode, ends after 10 min
②	Auto	return to Automatic mode
⑥	On	Switch on light (8 hrs)
⑦	Range +	Increase sensitivity
⑧	15 lux	Brightness setpoint value 15 lux
⑨	10 lux	Brightness setpoint value 10 lux
⑩	Lux On	Deactivation of brightness measurement
⑪	800 lux	Brightness setpoint value 800 lux
⑫	60 s	Lighting time delay 60 s
⑬	30 s	Lighting time delay 30 s
⑭	max. time	max. lighting time delay, 20 min
⑮	20 min	Lighting time delay 20 min
⑯	10 min	Lighting time delay 10 min
⑰	2 min	Lighting time delay 2 min
⑱	min. time	min. lighting time delay, 10 s
⑳	500 lux	Brightness setpoint value 500 lux
㉑	300 lux	Brightness setpoint value 300 lux
㉒	5 lux	Brightness setpoint value 5 lux
㉓	min. lux	min. brightness setpoint value, 1 lux
㉔	Range -	Reduce sensitivity
㉕	Teach-in	Teaching in the brightness setpoint value
㉖	Off	Switch off light
㉗	D mode	Twilight switch (motion detector deactivated)

Settings by using theSenda S (9070911)

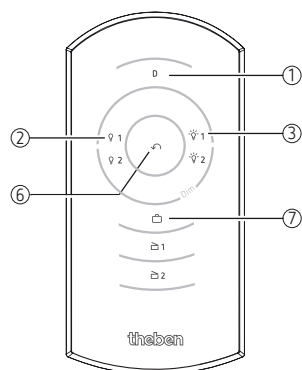

①	D mode	Twilight switch (motion detector deactivated)
②	Off	short button push -> switches off the light
③	On	short button push -> switches on the light
⑥	Auto	return to Automatic mode
⑦	Holiday mode	Presence simulation

Holiday mode

The holiday mode is a presence simulation, which is intended to prevent burglary during temporary absence.

10. Technical data

- Operating voltage: 230 V AC, +10 % – 15 %
- Frequency: 50 Hz
- Standby output: 0.3 W
- Detection angle: 220°, 300°
- Detection area: transverse: max. 16 m, frontal: max. 5 m
- Installation height: 2 – 4 m
- Creep under protection: yes
- Brightness setting range: 5 – 1000/∞ lux
- Duty cycle range: 1 s – 20 min
- Permissible ambient temperature: –25 °C to +45 °C
- Protection class: II
- Protection rating: IP 55 (wall mounting) and IP 54 (ceiling installation) (category II) according to EN 60529
- Switching capacity: 10 A (cos φ = 1)
10 AX (cos φ = 0.3)
- Min. switching capacity: 24 V/100 mA
- Switching contact: μ-contact 230 V AC
- LED lamps < 2 W: 60 W
- LED lamps > 2 W: 600 W
- Incandescent and halogen lamp load: 2300 W
- Low-voltage halogen lights: 2300 VA
- Fluorescent lamps VVG: uncorrected: 2300 VA
series-corrected: 2300 VA
parallel-corrected: 1300 VA (140 μF)
- Fluorescent lamps EB: 1200 W
- Compact fluorescent lamps EB: 300 W

11. Contact

Theben AG
Hohenbergstr. 32
72401 Haigerloch
GERMANY
Phone +49 7474 692-0
Fax +49 7474 692-150

Hotline

Phone +49 7474 692-369
Fax +49 7474 692-207
hotline@theben.de

Addresses, telephone numbers, etc.
www.theben.de