

## Description



- Motion detector (PIR)
- Automatic lighting control based on presence and brightness
- 150° detection angle
- For outdoor use
- Additional creep under protection
- Sensor head can be turned by  $\pm 90^\circ$  horizontally and by  $30^\circ$  downwards
- Adjustable brightness switching value and switch-off delay
- Mixed light measurement suitable for the control of fluorescent, incandescent, halogen lamps and LEDs
- Zero-cross switching for relay-saving switching and high lamp loads
- Teach-in of current brightness value possible
- Pulse function
- Test function for checking detection area
- Installation on flush-mounted socket possible (60 mm)
- Single-handed plug-in installation
- Instant start-up possible via factory preset
- Controls are place protected
- Terminal for protective earth conductor

## Technical data

Operating voltage	230 V AC
Frequency	50 Hz
Stand-by consumption	~0,9 W
Light measurement	Mixed light measurement
Number of channels	1
Colour	Black
Switching output	Light
Installation type	Wall installation
Setting range brightness	5 – 1000 lx
Switching capacity light	10 A (at 230 V AC, $\cos \varphi = 1$ ), 6 A (at 230 V AC, $\cos \varphi = 0.6$ ), 3 AX (at 230 V AC, $\cos \varphi = 0.3$ )
Detection angle	150°
Installation height	2 – 4 m
Light switch-off delay	1 s-20 min
Incandescent lamp load	2300 W
Fluorescent lamp load (conventional) not corrected	400 VA
Fluorescent lamp load (conventional) parallel-corrected	400 VA 42 $\mu$ F
Fluorescent lamp load (conventional) series-corrected	400 VA
Fluorescent lamp load (electronic ballast)	600 W
Energy saving lamps	150 W
Inrush current	max. 300 A / 200 $\mu$ s
LED lamp < 2 W	25 W
LED lamp 2-8 W	200 W
LED lamp > 8 W	200 W
Lamps	Incandescent/halogen lamps, fluorescent lamps, Energy saving lamps, LEDs

Article number: 1010501

Remote controlled	–
Ambient temperature	-25 °C ... +45 °C
Protection class	II
Type of protection	IP 55

### Connection example

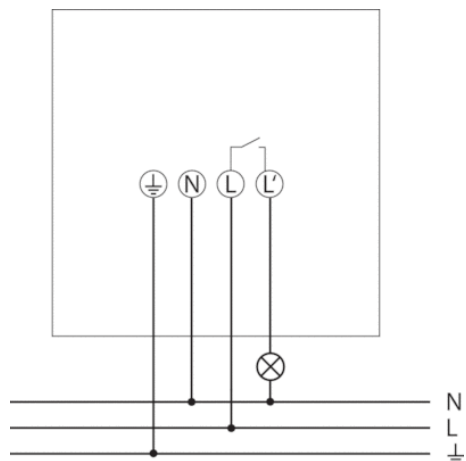

### Detection range

Mounting height (A)	Head on to (r)	Diagonally (t)
2 m	3 m	9 m
2,5 m	5 m	12 m
3 m	5 m	12 m
3,5 m	5 m	12 m
4 m	3 m	9 m

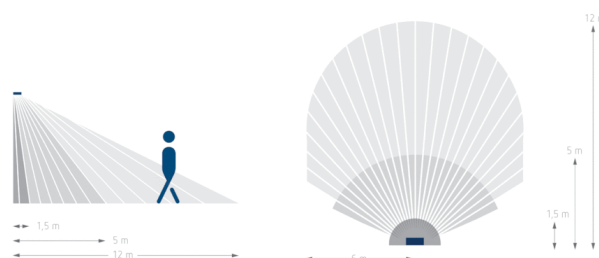

### Scale drawings

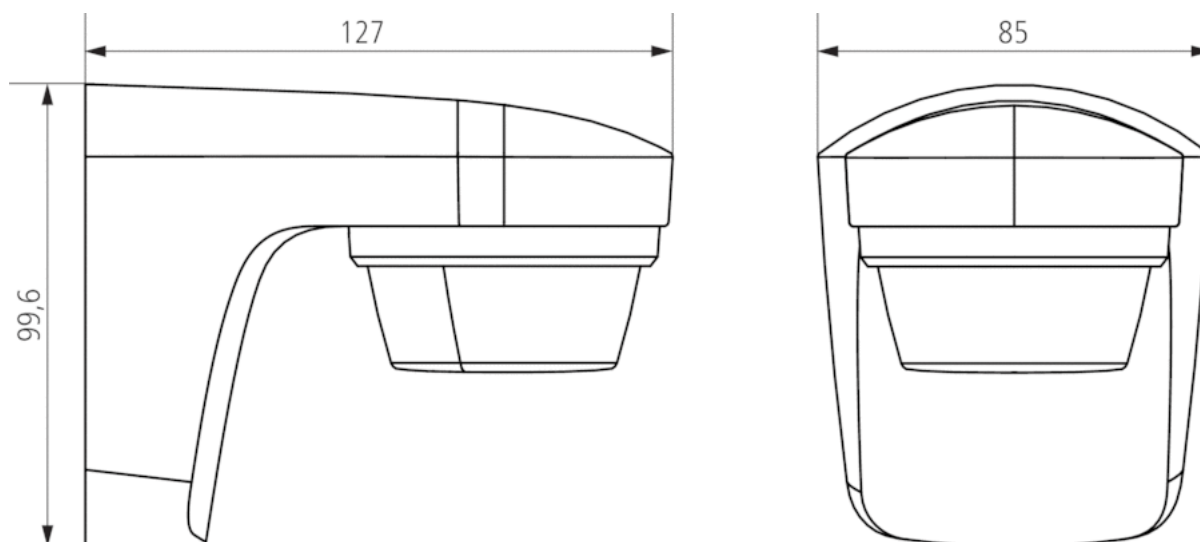

Article number: 1010501

## Accessories

---

### Corner angle theLuxa S BK

- Article number: 9070903  
[Details ▶ www.theben.de](http://www.theben.de)



### Spacer theLuxa S BK

- Article number: 9070907  
[Details ▶ www.theben.de](http://www.theben.de)

